

1964 FALCON REGISTERED OWNER'S MANUAL



46315

PAGE

- Registered Owner Plan..... 1

- Warranty..... 2

- Maintenance..... 11

- Controls..... 25

- Accessories..... 43

- Operation..... 49

- Ford Quality Car Care..... 64

Seal



THE FORD REGISTERED OWNER PLAN . . . your key to more carefree driving

The FORD REGISTERED OWNER PLAN enables you to obtain the full benefits of the more carefree driving that your new Ford is designed to give by providing three valuable benefits:

- Comprehensive warranty protection
- Simplified, low cost maintenance service
- Prompt, professional, personalized treatment at Ford dealerships.

The key element of the Plan is the *Ford Registered Owner's Manual* itself. This one, easy-to-keep reference book includes all the important information about your Ford, including your New Car Warranty, Battery Warranty, Tire Guarantee, periodic maintenance instructions and coupons, and detailed operating instructions.

Another important part of the Ford Registered Owner Plan is the useful all-new *Ford Registered Owner Identification card or Ownercard*. This is a plastic, embossed card containing your name and address along with code numbers identifying the model, engine and options of your new Ford. Ford Division will send your Ownercard to you approximately three weeks after you take delivery of your car. Keep this Ownercard handy by retaining it in the pocket provided on the inside front cover of this Manual.

1. validation of your new car warranty

By filling out the certificate on the inside front cover of this Manual, your Ford dealer registered you in the Ford Registered Owner Plan, and your signature on this certificate validated your 24 month/24,000 mile New Car Warranty.

Should you require any warranty service, your Ford dealer's factory-trained service personnel will explain fully any work that is required, and perform this work promptly under the terms of your warranty. (See Page 2 for details.)

2. convenient handling of preventive maintenance

Periodic Maintenance Coupons in the back of this Manual make it easy to obtain the FORD QUALITY CAR CARE maintenance services needed to keep your car in top operating condition. After each 6,000 mile or 6 months of operation, simply visit your Ford dealer and give him the applicable maintenance coupon, noting any additional work you care to have done. (See Page 64 for details.)

Your dealer's verification of the services performed on the appropriate Maintenance Stub in your Manual gives you a valuable, permanent "Log Book" of the services performed during the period of your ownership.

the Ford Registered Ownercard: how to use it . . . how to replace it

The Ford Registered Ownercard is for your use whenever you visit your Ford dealer. It helps to identify you and supplies valuable information to the dealership with reference to the model, engine and options of your Ford. The Ownercard is particularly valuable in expediting your dealer's diagnosis and write-up operation, thereby minimizing your time in the Service Department. In addition, it can expedite and simplify handling of any warranty problems which may arise.

Should you lose your Ownercard or change your address, you can obtain a new card either by requesting one through your Ford dealer, or by writing *Ford Division, Ford Motor Company, P.O. Box 428, Dearborn, Michigan*. When writing personally, explain the reason for needing a new card and indicate any corrections to be made on the card (such as a new address). In addition, *be sure to include the vehicle code number of your car*, which can be found on the warranty plate located on the rear face of the left front door inner panel.

If you purchase a *used* 1964 Ford within the warranty period, notify the Ford Division and an Ownercard will be mailed to you upon receipt of your request as outlined above.

THIS IS YOUR FORD DEALER'S NEW CAR WARRANTY

Ford Motor Company has warranted to the Dealer who, pursuant to his sales agreement with the Company, hereby, on his own behalf, warrants to the owner each part of this Ford vehicle to be free under normal use and service from defects in material and workmanship for a period of 24 months from the date of delivery to the original retail purchaser or until it has been driven for 24,000 miles, whichever comes first. This warranty shall be fulfilled by the Dealer (or if the owner of the vehicle is traveling or has become a resident of a different locality, by any authorized Ford dealer) replacing or repairing at his place of business, free of charge including related labor, any such defective part.

This warranty shall not apply to (i) tires or tubes (appropriate adjustments for them being provided by their manufacturers), or (ii) to normal maintenance services (such as engine tune-up, fuel system cleaning and wheel, brake and clutch adjustments), or (iii) to normal replacement of service items (such as filters, spark plugs, ignition points, wiper blades and brake or clutch linings), or (iv) to deterioration of soft trim and appearance items due to normal use or exposure.

This warranty is expressly IN LIEU OF any other express or implied warranty, including any implied WARRANTY of MERCHANTABILITY or FITNESS, and of any other obligation on the part of the Dealer.

For further clarification of this warranty and its liberal coverage, refer to Page 3.

EXPLANATION OF THE WARRANTY

pre-delivery:

Your complete satisfaction with your Ford is of prime concern to the selling dealer. For this reason, the selling dealer has carefully performed any necessary mechanical and body inspection, alignment and adjustment operations to be sure that its appearance and performance meet the regular high standards for Ford Motor Company products. These operations are performed according to the pre-delivery inspection schedule recommended by Ford. However, if you feel that your car requires additional inspections, alignments, or adjustments you are urged to return immediately to your selling dealer so that he can make the necessary corrections.

Depending on your individual driving habits, usage of the vehicle and type of terrain on which the vehicle is operated, additional mechanical and body alignments, adjustments or tightening operations may become necessary. Normally, if conditions requiring these operations are found to exist after your first 6,000 mile inspection, their correction will be regarded as a part of normal maintenance and such services will be performed at your expense.

warranty rights:

The warranty coverage of 24 months or 24,000

miles, whichever comes first, applies to the entire vehicle except tires and tubes which are warranted by their manufacturer. During this period any part which is found to be defective in material or workmanship will be replaced or repaired free of charge by your selling dealer. Be sure to read the Ford Dealer's New Car Warranty statement on Page 2.

owner responsibility:

The warranty does not cover normal maintenance services such as engine tune-up, fuel system cleaning, front wheel alignment and wheel balancing, brake and clutch adjustments, nor normal replacement of service items such as filters, spark plugs, ignition points, wiper blades, brake and clutch linings.

In addition the warranty does not cover the mechanical and body alignments, adjustments or tightening operations which may become necessary through normal use.

The regular maintenance and care of your vehicle by competent factory-trained technicians will help you avoid unnecessary expense for these maintenance items. For this reason the Ford Quality Car Care service recommendations contained in this Manual should be performed either at the time and mileage intervals specified or on an "as required" basis depending on the recommendation. You will be charged by the dealer for these operations.

paint and other appearance items:

During the pre-delivery inspection, imperfections in paint, trim or other appearance items normally are apparent and corrected. The warranty does not cover deterioration of soft trim and appearance items due to normal use or exposure. If after taking delivery of your new vehicle you discover an imperfection, you should call it to the attention of your selling dealer so that he may make the necessary correction.

traveling or change of residence:

When traveling or in the event you become a resident of a different locality any authorized Ford dealer can honor the New Car Warranty.

sale of vehicle to subsequent owners:

If you sell or trade your vehicle while it is still within the terms of the New Car Warranty the subsequent owner is entitled to the same warranty privileges as you during the unexpired portion of the warranty period. If possible, he should return to your selling dealer for warranty service. However, if this is not practicable, any authorized Ford dealer can honor the New Car Warranty in the event warranty corrections are required.

BATTERY WARRANTY

The Autolite Battery which is installed in your new car at the time of delivery is guaranteed by your dealer against defects in material and workmanship for a period of 36 months from the time you purchase the car. This protection varies with the length of time the car has been in use and the mileage the car has been driven as outlined below.

Batteries which fail because of defect during the first 24 months or 24,000 miles, whichever occurs first, will be replaced on a no-charge basis.

Batteries which fail after the first 24 months or 24,000 miles of service, whichever occurs first, will be replaced on a pro rata basis.

This pro rata adjustment provides you with a credit toward the purchase of a new Autolite battery. This credit is based on the number of months remaining in the pro rata period at the time the battery is found defective. For example, if the battery fails during the 25th month of service you will receive 11 months credit toward the purchase of a new Autolite battery.

If a battery should fail within the first 24 months of service

but after 24,000 miles the pro rata adjustment will be based on the number of months in service. For example, if the battery fails during the 20th month of service, but after 24,000 miles of driving, then you will receive 16 months of credit.

This pro rata guarantee period applies to normal passenger car usage. If your car is used as a police car or taxicab, see your dealer for the guarantee period details.

NEW TIRE GUARANTEE

As noted in your Ford Dealer's New Car Warranty, your tires are separately warranted by the tire manufacturer. This warranty provides you with protection against a defect in workmanship and/or material, under the lifetime warranty, and against the hazards covered by the Road Hazard Warranty. The Ford Registered Owner Plan Identification on the inside front cover, serves to identify you, and to indicate the registration date of your car ownership. Should either type warranty service be required, show this registered owner information to the tire manufacturer's representative.

Your Ford dealer will assist you in presenting any tire problem to the tire manufacturer's designated field station.

THE VALUE OF REGULAR MAINTENANCE

Your selection of a Falcon identifies you as a person who understands value and who wants to obtain the most for the money you spend. So certainly you will want your Falcon to retain its value throughout the years of service that it is capable of giving you.

Like any fine machine, your car requires a certain amount of attention to keep it in good operating condition. In this car the amount of attention required has been reduced to a level never possible in past years. For instance, adjustments and minor lubrications are required only every 6 months or 6,000 miles (whichever comes first) while major chassis lubrication is required only every 3 years or 36,000 miles (whichever comes first). The engine oil and oil filter need be changed only every 6,000 miles or 6 months (whichever comes first). Two easy and convenient visits a year to your Ford dealer's service department will, in most cases, take care of these requirements effectively.

There are a few **VERY IMPORTANT** items, however, that only **YOU** are in a position to control. Although they might appear to be relatively minor, they can have a profound effect on how reliably your car will serve you and on the prevention of costly repairs.

THE OWNER'S RESPONSIBILITIES FOR MAINTENANCE

1 check engine oil level frequently

It is important to have the engine oil level checked each time you stop for fuel. Add oil as required so that the oil level stays between the "full" and "add oil" marks on the dipstick. It is normal to add some engine oil between the 6,000-mile oil changes. Requirements will vary with driving conditions but the addition of one quart each 1,000 miles would not be excessive. **DO NOT OPERATE THE ENGINE WITH THE OIL LEVEL BELOW THE "ADD OIL" MARK.**

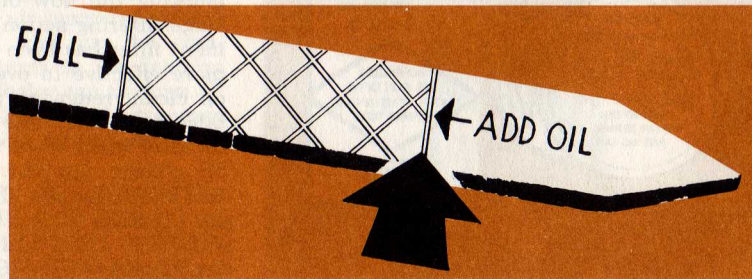

2 use the right engine oil

IT IS IMPORTANT to use only engine oils certified by the maker to have passed the automobile manufacturers' SEQUENCE TEST SPECIFICATIONS. (See page 62.) In practically all cases, 10W-30 oil will meet these requirements and will be correct for most weather conditions.



3 use the right oil filter

The engine oil filter is **EVEN MORE IMPORTANT** in preserving the internal condition of your engine. Your new car is equipped with a Rotunda oil filter which should be changed each time you change engine oil. For reliable service, you should always specify a genuine Rotunda replacement filter. It is designed to protect your engine by filtering all harmful abrasive or sludgy particles without clogging up and blocking the flow of oil. The exclusive two-stage filtering action of the Rotunda replacement filter has been shown by tests to be far more effective in over-all ability to keep the oil clean, removing particles even finer than talcum powder. The Rotunda oil filter is *the* oil filter which made a 6,000 mile (or 6 month) oil change interval possible. **YOUR BEST EVIDENCE OF THE RIGHT FILTER IS TO SEE FOR YOURSELF THAT THE FILTER INSTALLED ON YOUR CAR CARRIES THE ROTUNDA NAME AND**

THE UNIQUE ROTUNDA SHAPE.

Use of the recommended oils and the ROTUNDA filter is essential to successful operation with 6,000 mile (or 6 month) oil change intervals. Use of an engine oil or oil filter other than specified here will require more frequent engine oil and filter changes.

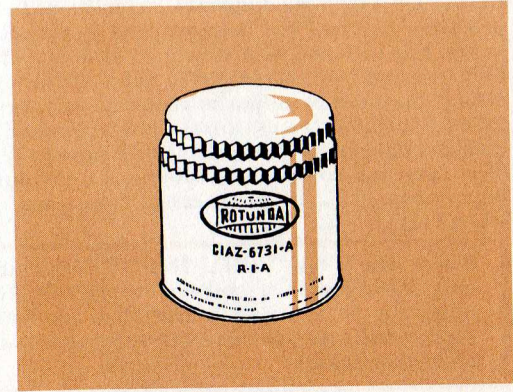

4 use the right fuel

Your engine will usually operate efficiently under most operating conditions using the grade of fuel indicated below.

ENGINE	GRADE OF FUEL RECOMMENDED
144 cu. in. 6-cylinder	Regular (at least 91 Octane*)
170 cu. in. 6-cylinder	Regular (at least 91 Octane*)
200 cu. in. 6-cylinder	Regular (at least 91 Octane*)
260 cu. in. V-8	Regular (at least 92 Octane*)

*Octane as rated by the Research Method.

Generally, the grade of fuel recommended will provide satisfactory engine performance. However, if “pinging” or “spark knock” occurs and cannot be cured by spark timing or other engine adjustments, change to the next higher grade of fuel. If you plan to drive your car outside the United States or Canada, ask your travel agent or auto club about the quality of gasoline available in the area you expect to visit. The octane rating of gasolines will vary in different parts of the country. Also the octane requirements of your engine will vary with changes in air temperature and altitude. In most cases, this can be compensated for by adjustments to the ignition timing which your Ford dealer can perform. If you use a high octane fuel, take full advantage of it by having your ignition timing advanced.

5 check the coolant

Your cooling system has been filled with a special Rotunda long life coolant. This prevents corrosion and keeps the cooling system clean for best operation summer and winter. In winter, it provides anti-freeze pro-

tection to -35°F and in warm weather permits your engine to operate at temperatures up to 250°F without boiling. This coolant is good for two years (or 36,000 miles) of operation if not lost by leakage or overflow.

For most effective cooling and engine protection, you should maintain this coolant at its original strength all year round and in all climates.

If it is necessary to add coolant, we recommend *undiluted* Rotunda All Season Engine Coolant





for all the 260 cu. in. engines (because they incorporate aluminum parts). In other engines, it is also permissible to use a good ethylene glycol anti-freeze, such as Rotunda Permanent Anti-freeze, mixed 50-50 with water.

In an emergency, any reputable brand of permanent (ethylene glycol) anti-freeze may be mixed 50-50 with water and added.

You should check the level of coolant about once a month. It should be about an inch below the ring inside the filler neck. **DO NOT FILL ABOVE THIS LEVEL.** If you have to add coolant more than about once a month, or if you have to add more than a quart at

one time, have your Ford dealer check the cooling system for leaks or other trouble.

It is best to check this when the engine is cool. When the temperature indicator is above the "cold" end of the dial, you must be very careful about removing the cooling system filler cap because the internal pressure can blow out scalding fluid and vapors. Best way is to muffle the cap in a thick rag and turn it open gradually until pressure just starts to escape. When the pressure is down, the cap can be fully removed.

Have the degree of anti-freeze protection checked at regular intervals to be sure that your cooling system is protected fully.

See page 17 for further details.

6 check the battery

About once a month (more often during hot dry weather) have the fluid level in the battery cells checked. The level should be at the ring in the bottom of the filler well. Ordinary tap water can be used

except in areas where the water is known to be exceptionally hard or to have a high mineral or alkali content. In cold weather it is a good idea to have the battery state of charge checked every few weeks. If low, a light charge will prevent hard starting sometime when you are in a hurry.

See Page 19 for more detailed information.

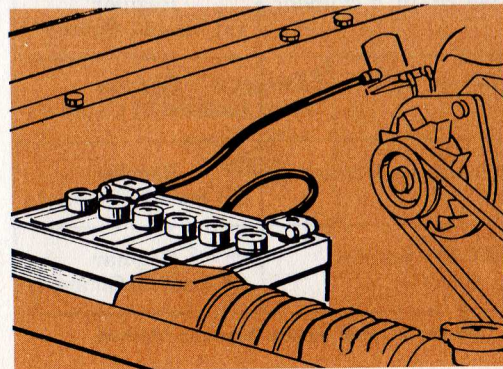

7 watch your engine TEMPerature indicator

Normally the pointer should stay within the range indicated by the solid band on the dial. There is no danger to the engine unless the pointer goes all the way to the line at the "H" end of the dial. If it does, stop

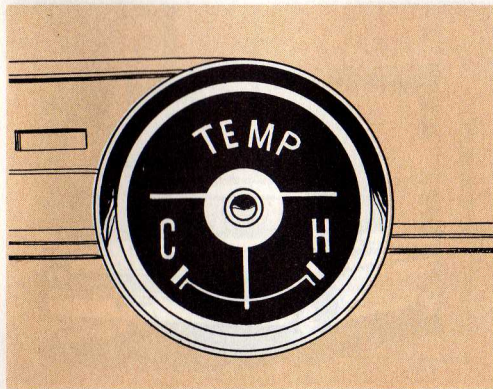

the engine to let it cool. Check the coolant level, following the previous instructions about care in removing the filler cap. If the coolant is low, add coolant gradually with the engine running as explained more fully on pages 7 and 8. In any case, drive by easy stages to where you can get help, stopping to let the engine cool whenever it gets too hot.

8 watch your OIL pressure light

If the red "OIL" pressure warning light comes on while you are driving, slow down promptly and stop the engine. **DO NOT RUN THE ENGINE WITH THIS LIGHT ON.** The light may occasionally glow or flicker when the engine is idling slowly. This is not harmful. The light **MUST** go out, however, as soon as the engine speed is increased above idle. If it stays on, check the engine oil level and add oil if it is low. This may correct the problem. If it does not, send for help. **DO NOT ATTEMPT TO DRIVE THE CAR IN FOR SERVICE.**

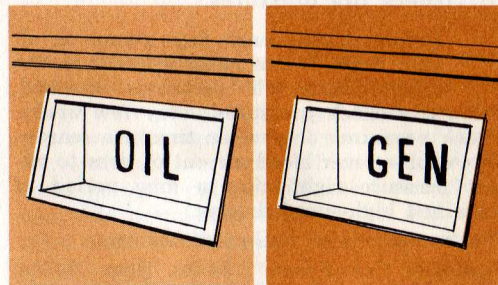

9 watch your GENERator warning light

This light also may glow or flicker at idle speeds. If it stays on when engine speed is increased above idle, it means that your generating system is not charging the battery. In this case, it is alright to drive to the nearest place to get help, but do this *immediately* because your battery will soon run down and then the engine will not operate.

10 check tire pressures

Before driving each day, glance at all your tires. If one looks softer than the others, have all pressures checked. Otherwise check pressures every few weeks. Check pressures only when tires are reasonably cool – never bleed air out of tires to adjust pressure right after a long period of sustained high-speed driving.

The recommended tire pressures are:

Passenger Car—Front . .24 lbs. Rear . .24 lbs.
Station Wagon—Front . .24 lbs. Rear . .28 lbs.

For better gas economy, high speed driving, or for heavy loads it is desirable to inflate tires 4-6 lbs. above recommended pressures.

11 keep the upholstery and finish clean

Your Falcon has been painted with a Diamond Lustre finish, one of the hardest and most durable finishes ever used on a car. While it does not require wax to maintain its lustre, it should be washed often

enough to prevent heavy build-ups of road film, salt, etc., which might gradually erode the finish.

The use of a good polish such as Rotunda Custom Silicone Gloss will make washing and removal of bug-spots and road deposits easier while it provides extra protection for the finish. The same care will preserve the chrome and bright metal trim. Similarly dirt and dust trapped in the upholstery acts as an abrasive and the life of these materials can be lengthened by cleaning reasonably often. When cleaning vinyl surfaces, use only a recommended vinyl cleaner like Rotunda Triple Clean. Harsh kitchen cleansers may damage the surface coating of the vinyl and make future cleanings much more difficult.

12 have the recommended maintenance services performed

Take the car to your Ford dealer every 6 months or every 6,000 miles (whichever comes first). He is thoroughly familiar with the maintenance requirements of your

Falcon, and has the factory-trained technicians, factory-approved equipment and Genuine FoMoCo and Rotunda parts and lubricants necessary to provide the recommended FORD QUALITY CAR CARE maintenance services prescribed on the coupons at the back of this book. All these services will be provided at a reasonable cost to you.



MAINTENANCE

In addition to the items of day-to-day care listed on the preceding pages, you should . . .

- See your Ford dealer every 6,000 miles or 6 months for the Ford Quality Car Care maintenance operations prescribed on the coupons at the back of this book.
 - Watch for the symptoms described on page 16 for other maintenance required.
 - The following pages give some additional information which will be helpful.
-

Your automobile is equipped with an extended chassis lubrication feature which was pioneered by Ford Motor Company. This extended lubrication interval is made possible by a completely new type chassis lubricant combined with special seals and bearing materials which completely outmodes the old concept of 1,000 mile chassis lubrication. The new lubricant used by Ford Motor Company contains molybdenum disulphide and is one of the longest-lasting, most friction-free lubricants known to man. It provides the advantages of a consistently good ride over extended periods of time and also saves time, inconvenience and expense.

You may encounter uninformed service people who will recommend that conventional lubrication fittings be installed and that you have the car lubricated every 1,000 miles. This is completely unnecessary and, in fact, may

cause damage to the special seals used in the lubrication points. More important, the warranty, as it relates to this part of the car, does not cover damage caused by improper use of conventional lubricants which can destroy seals, be incompatible with the factory lubricant and permit the entry of dirt and water after special sealing plugs have been removed.

Your best bet for expert service and expert service advice is to return to your dealer for Quality Car Care. His facility is equipped to remove the special plugs in the lubrication points at 36,000 miles so that they may be refilled with factory-type Ford lubricant. His application of the special greases combined with the reinstallation of the original plugs after greasing will protect lubrication points from damage caused by the entry of dirt and water.

BEAUTY MAINTENANCE

Your new Falcon has a Super Enamel "Diamond Luster" finish. This is a finish of maximum beauty which in depth of color, gloss retention and durability is superior to conventional automobile finishes.

washing

The best way to preserve the finish is to keep it clean with frequent washings. Wash the car with either warm (never hot) or cold water, not in the direct rays of the sun and not while the sheet metal surfaces are hot. Never wipe the dirt from dry painted surfaces, as this may scratch the finish. The use of strong soaps or detergents should be avoided. Any cleaning agent used, such as Rotunda Liquid Car Wash, should be promptly flushed from the surface with clear water and should not be allowed to dry, as it may streak the finish.

polishing

Even though the finish on your Falcon is

more durable and retains its gloss better than conventional automobile finishes, polishing will further enhance the beauty of its "Diamond Luster" finish.

Polishing your car with Rotunda Custom Silicone Gloss will provide an added degree of protection against road salts, ice melting agents, road oil and tar, tree sap, industrial fallout from factory chimneys and other foreign matter which, if allowed to remain in contact with the paint film, can damage any automobile finish.

touching-up paint

After washing the car, it is a good policy to examine the body for stone and parking lot paint nicks or chips. These should be touched up immediately, before weathering action begins. Touch-up paint to match your Ford color is available at your Ford dealer.

bright metal

The bright metal trim on your car requires

the same care as the painted surfaces. Where salt is used on streets for snow removal, wash more frequently than usual to prevent discoloration. Rotunda Chrome Cleaner may be used to remove rust or salt corrosion, and Rotunda Chrome Protector will help keep your chrome in excellent condition.

windshield wipers

Windshield wipers should be checked regularly to make sure that the blades are free from grit and that only the rubber portion is contacting the glass. Rotunda Windshield De-Icer sprayed onto your windshield will make it easy to remove snow, sleet or ice. Use a scraper with a plastic or rubber blade only. If the ice contains road grit, use Rotunda De-Icer or warm water to melt the ice; then remove with a rubber squeegee.

tires

Wash your tires with clear water or water

with a mild detergent added. Tar, road oil and similar substances can be removed with Rotunda Tar and Road Oil Remover. White side wall tires are easily cleaned using Rotunda Triple Clean. Use the cleaner as directed on the container. A stiff-bristled brush or fine steel wool can be used to remove stubborn scuff marks.

vinyl-covered roof, convertible top, and convertible back window

Plain water will ordinarily be sufficient to clean either the convertible top or the optional vinyl roof supplied on hardtop models. However, when it becomes necessary to remove accidental soilage or accumulated grime and dirt, either top can be cleaned as shown below:

1. Rinse the top or roof with clear water to remove loose dirt or grime.
2. Apply Rotunda Triple Clean following the directions on the container. Use a soft bristle

brush and work only a two foot square area at a time. Carefully overlap each section to avoid streaking.

3. Rinse the top and repeat the operation.

To avoid scratching the flexible rear window, never wipe the plastic with a dry cloth. Use a damp cloth and light pressure. When necessary to clean the flexible window, proceed as follows:

1. Rinse any mud or loose dirt from the window with clear water.
2. Apply a small quantity of Rotunda Convertible Rear Window Cleaner directly to the window. Use a soft dry cloth and rub the window briskly. This will remove any film or light scratches present.
3. Allow the cleaner to dry and then polish with another soft cloth.
4. Do not allow the cleaner to dry on painted or vinyl surfaces.

upholstery

Fabric upholstery should be brushed or vacuum-cleaned regularly. Generally, oily or gummy stains can be removed with Rotunda Spot Remover. Organic stains are best removed with cold water, followed by application of Rotunda Triple Clean. Avoid saturating foam-padded fabric with spot remover.

Vinyl trim and upholstery can be kept soft and clean by regular use of Rotunda Triple Clean. This is a specially compounded conditioner for such materials, and is available at your Ford dealer.

carpeting

Your carpeting should be cleaned regularly, using a whisk broom to loosen sand and dirt, followed by vacuum cleaning. Rotunda Spot Remover may be used to remove oily or gummy deposits. Rotunda Triple Clean used as a shampoo will help to restore the original appearance and texture. Wash rubber mats with mild detergent or soap and water.

GENERAL MAINTENANCE RECOMMENDATIONS

All Falcon passenger cars have the following parts filled at the factory with a high quality lubricant designed for use throughout the life of the vehicle: manual transmission, automatic transmission, power steering reservoir, steering gear housing and rear axle.

These lifetime lubricants need not be changed in any of these parts. Rather, the lubricant supply should be checked periodically and the proper lubricant "added to" when needed.

Instructions for checking these and other units are contained in the following paragraphs. Locations of the engine-compartment components are shown on this page and page 15. Specified lubricants are given on Page 62.

checking the automatic transmission fluid level

With the engine running at idle speed, the fluid at a normal operating temperature, and the transmission selector lever at P (park), the fluid level should be at the Full mark on

the dipstick. Wipe the dipstick clean before inserting and seat it firmly after reading the level. Do not overfill the transmission.

checking the engine oil level

Check the oil level as the last step in a fuel-stop, or before operating the engine in the morning. This will allow the normal accumulation of oil in the engine to return to the crankcase. Remove the dipstick, wipe it clean and re-insert it for an accurate reading. Seat it firmly after reading the level. Further oil maintenance instructions are contained on Pages 5 and 6.

checking the battery level

Wipe the battery fillers off with a cloth or facial tissue before removing. Rotate the caps counterclockwise to remove. Maintain the fluid in each battery cell so that it is level with the ring in the bottom of the filler well. Refer to Page 18 for further instructions on general battery care.

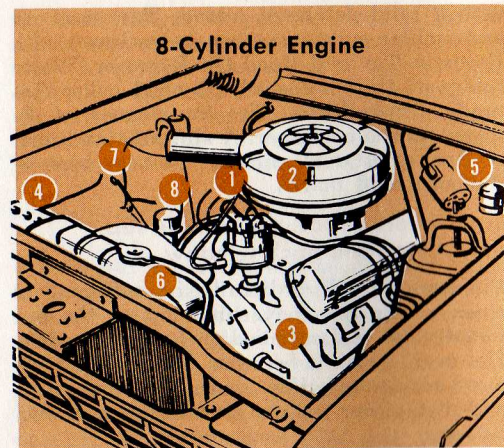

- ① Transmission Fluid Dipstick ② Air Cleaner
③ Power Steering Reservoir ④ Battery
⑤ Brake Master Cylinder ⑥ Radiator Cap
⑦ Engine Oil Dipstick ⑧ Oil Filler Cap

6-Cylinder Engine

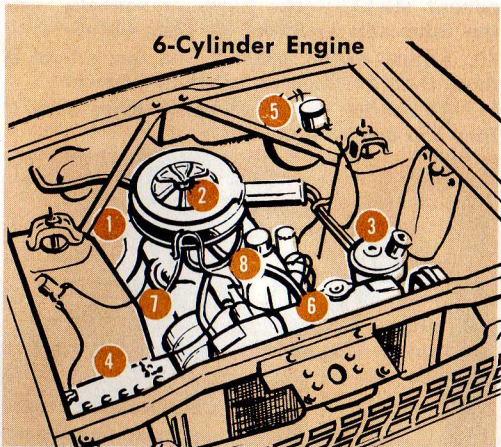

- ① Transmission Fluid Dipstick
- ② Air Cleaner
- ③ Power Steering Reservoir
- ④ Battery
- ⑤ Brake Master Cylinder
- ⑥ Radiator Cap
- ⑦ Engine Oil Dipstick
- ⑧ Oil Filler Cap

positive crankcase ventilation system

Air pollution is a source of concern to all of us. To combat this problem, Ford Motor Company has equipped your car with a positive crankcase ventilation system which appreciably reduces the amount of crankcase fumes released to the atmosphere. It has been designed to operate with minimum maintenance which will be taken care of by your Ford dealer as part of your regular Ford Quality Car Care maintenance covered by the coupons in the back of this book.

servicing the oil breather filler cap

The oil filler cap contains an air filter because air for the crankcase ventilation systems is drawn into the engine at this point. This filter is serviced as part of the regular Ford Quality Car Care maintenance by your dealer.

checking the brake fluid level

Wipe off the brake master cylinder filler cap and rotate counterclockwise to remove. The fluid level should be maintained about $\frac{3}{8}$ inch from the top of the master cylinder. Tighten the cap securely.

servicing the air cleaner

The air cleaner will be serviced by your Ford dealer during each 6,000 mile maintenance inspection.

checking the power steering fluid level

Start the engine, turn the steering wheel all the way to the left and right several times, and shut off the engine. Check the power steering fluid level. This inspection is another service performed by your Ford dealer as a regular part of the Ford Quality Car Care maintenance.

OTHER MAINTENANCE REQUIRED

There are certain maintenance operations which are not required at definite periodic intervals but should be performed on an as-required basis. The most effective and economical practice is to have your Ford dealer check these items only when the way your car is operating indicates they are necessary.

1. Carburetor idle speed and mixture . . .

Should be adjusted if engine stalls, idles too fast, or idles roughly.

2. Distributor points and/or spark plugs . . .

Should be cleaned, adjusted, or replaced if engine misses, is hard to start, loses "pep" on acceleration, or if fuel economy decreases (note: fuel economy will normally be less in cold weather than when it is warm).

3. Fordomatic . . .

Adjust bands if transmission "slips" or grabs sharply when shifting. Lubricate transmission kickdown linkage if abnormal accelerator pressure is required to downshift into passing gear.

4. Steering gear preload . . .

Adjust if steering wheel feels "loose" while driving in the "straight ahead" position.

5. Windshield wiper blades . . .

Replace if blades do not wipe windshield clean after you have wiped the blade off with a clean cloth.

6. Convertible top fluid reservoir . . .

Fluid level should be checked (and fluid added if necessary) if top operates more slowly than usual, is noisy, or stops in the course of raising or lowering.

7. Battery charge . . .

Have battery checked (and recharge if necessary) if starter turns engine more slowly than usual.

8. Carburetor accelerator pump . . .

When average outside temperature changes more than 30°F., adjust to leanest setting that prevents engine "hesitation" while accelerating.

9. Body hinges and locks . . .

The movable mechanical parts of the body are lubricated at the assembly plant for

proper quiet operation. If a mechanical component sticks, works hard, or squeaks, use the lubricants specified on page 63.

10. Adjust clutch pedal if the free travel is more than 1 1/8 inch or less than 1/8 inch.

11. Adjust the engine accessory drive belts if they slip and/or squeal.

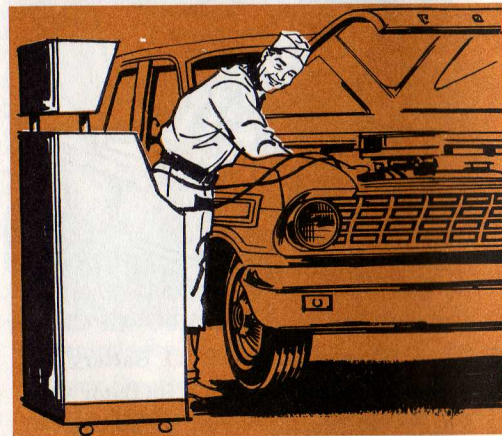

COOLING SYSTEM CARE

Your cooling system has been filled with a special Rotunda long life coolant. It prevents corrosion and keeps the cooling system clean for best operation summer and winter. In winter, it provides anti-freeze protection to -35°F and in warm weather permits your engine to operate at temperatures up to 250°F without boiling. This coolant is good for two years (or 36,000 miles whichever comes first) of operation if not lost by leakage or over flow. For most effective cooling and engine protection, you should maintain this coolant at its original strength all year round and in all climates.

If it is necessary to add coolant, we recommend *undiluted* Rotunda All Season Engine Coolant for all the 260 cu. in. engines (because they incorporate aluminum parts). In other engines, it is also permissible to use a good ethylene glycol anti-freeze, such as Rotunda Permanent Anti-freeze, mixed 50-50 with water.

In an emergency, any reputable brand of permanent (ethylene glycol) anti-freeze may be mixed 50-50 with water and added.

Whenever the cooling system is completely refilled, add one can of Rotunda Radiator Rust Inhibitor.

Approved permanent anti-freeze such as Rotunda Permanent Anti-freeze may also be added undiluted if anti-freeze protection below -35°F is required.

You should check the level of coolant about once a month. It should be about an inch below the ring inside the filler neck. **DO NOT FILL ABOVE THIS LEVEL.** If you have to add more than a quart at one time, have your Ford dealer check the cooling system for leaks or other trouble.

It is best to check this when the engine is cool. When the temperature indicator is above the "cold" end of the dial, you must be very careful about removing the cooling system filler cap because the internal pressure can blow out

scalding fluid and vapors. Best way is to muffle the cap in a thick rag and turn it open gradually until pressure just starts to escape. When the pressure is down, the cap can be fully removed.

Have the degree of anti-freeze protection checked at regular intervals to be sure that your cooling system is protected fully. Regular inspections of the cooling system may reveal minor troubles which can be corrected quickly and inexpensively before they result in costly repairs to either the cooling system or the engine.

Hose leaks can frequently be stopped by tightening the clamps but cracked or broken hoses should be replaced.

A loose fan belt can cause overheating in traffic.

Bugs, leaves, papers, etc. that might restrict the flow of air through the radiator may be blown out with an air or water hose from the rear of the radiator.

ELECTRICAL SYSTEM CARE

fuse replacement

For convenience, most of the replaceable fuses for your car's electrical system are located on the panel attached to the rear of the LIGHTS switch. The fuse panel is located behind the instrument panel just below the light switch.

The locations of other fuses are indicated on page 61. If a fuse needs to be replaced (see page 23), use only a new fuse rated according to the specifications on page 61.

circuit breakers

Selected circuits, such as headlights, are protected with circuit-breakers. A circuit breaker is designed to stop current flow in case of a short-circuit or overload. It will automatically restore current flow after a few seconds, but will again interrupt current if the overload or short-circuit continues. This on-off cycle

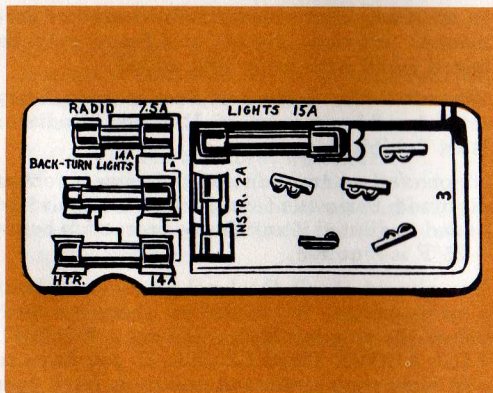

will continue as long as the overload or short-circuit exists. Refer to page 61 for a list of components protected by circuit-breakers.

Your Ford dealer or service station attendant can help you if you should have electrical trouble requiring fuse replacement or electrical circuit repairs.

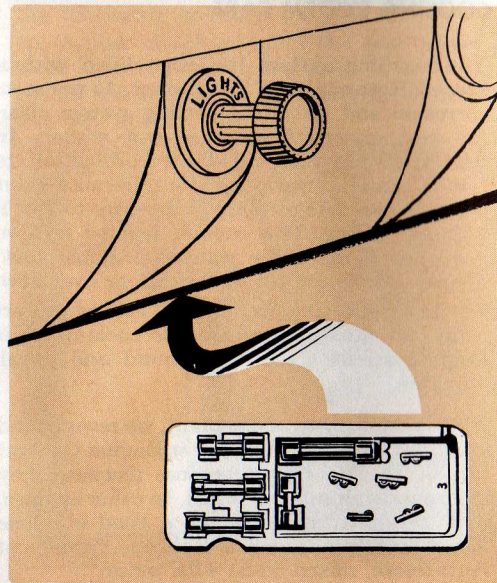

checking the battery

Because the battery is the "heart" of your car's electrical system, periodic checks are necessary to keep it functioning properly.

Keep the battery fluid level up to the ring under the filler cap. Ordinary tap water may be used except in areas where the water is known to be exceptionally hard or to have a high mineral or alkali content. If water is added during freezing weather, drive the car five or six miles before shutting it off. This mixes the added water with the electrolyte and will prevent it from freezing and damaging the battery.

Have the battery charge checked regularly during extremely cold weather, to make sure it has enough power to do its job. Make sure the cables are clean and tightly clamped to the battery terminals.

Corrosion can be removed from the cables and terminals with a solution of baking soda or ammonia and water. After cleaning, flush the

top of the battery with clean water, and coat the parts with grease to retard further corrosion.

headlight and lamp replacement

To replace a headlight, remove the headlight trim cover retaining screws and remove the cover. Then loosen, but don't remove, the three retaining ring screws shown in the illustration. Rotate the headlight retaining ring counterclockwise and pull it forward so that the headlight can be unplugged and removed. Plug in the new headlight and install it and its retaining ring in position. Rotate the retaining ring clockwise on the three screws and tighten the screws. Then install the trim ring.

New replacement lamps are available from your Ford dealer. The lamp specifications for all the lights in your Falcon are listed on page 61.



tire care

Performance, ride, and handling qualities of any car are much influenced by tire condition and pressure. A good policy is to inspect your tires visually every day and to have the pressure checked regularly. If you notice irregular or unusual tire wear, have your Ford dealer inspect the tire and associated parts. Tire pressure specifications are given on pages 10 and 61.

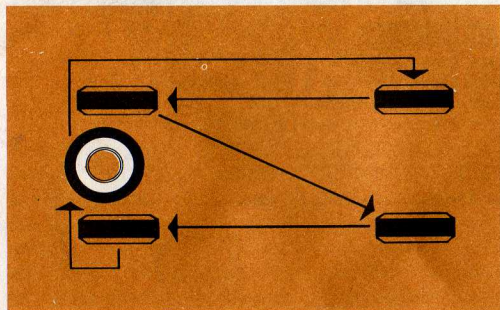

Cross-switching tires will equalize tire wear and may improve smoothness of ride but the improvement may not justify the cost of having it done. If it becomes necessary, the pattern below is recommended.

changing a wheel

The spare wheel and tire, jack, and jack handle are stored in the luggage compartment. In the Station Wagons they are located in the right rear quarter panel.

Before the car is jacked up, apply the parking brakes and, as an added precaution against moving, place a large stone or block under the front and rear of one wheel. Do not run the engine when the car is on a jack. After loosening the wheel nuts, place the jack in the notched space under the front or rear bumper as shown in the illustrations. Then jack up the car and change the wheel. Tighten the wheel nuts on the replacement wheel, and lower the car slowly to the ground. Check all the wheel nuts again to be certain they're tight.

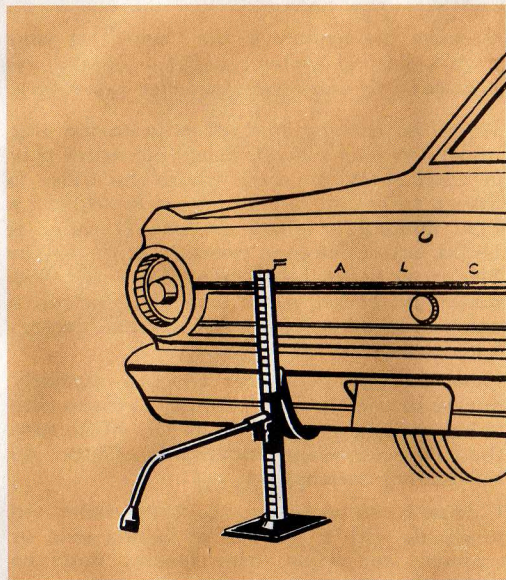

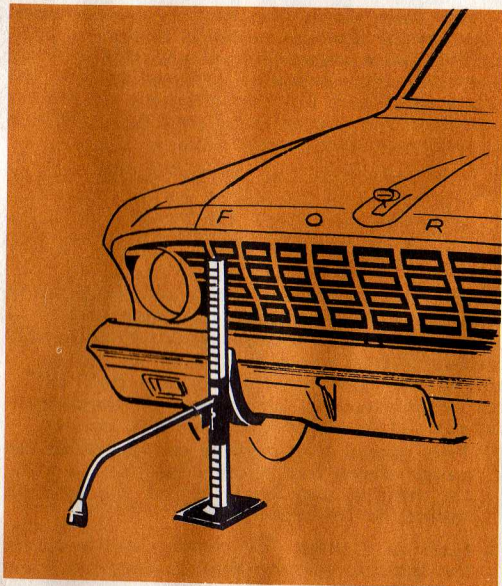

stowing the tire jack and spare wheel

To eliminate the possibility of the jack and spare wheel rattling while the car is moving, stow them properly, as shown in the applicable illustration.

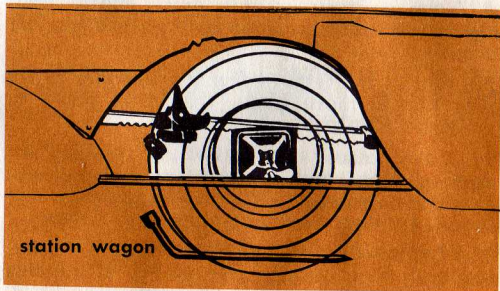
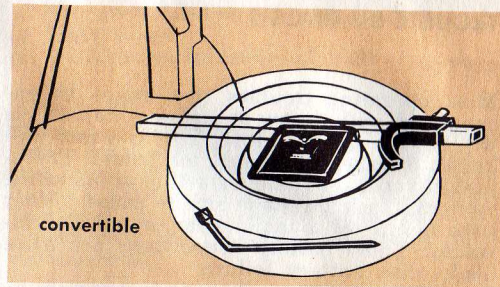

TROUBLE DIAGNOSIS

general

Most operating troubles that might be encountered with a new or well-maintained car will be of a minor nature. This is a fact well known to experienced auto mechanics. Therefore, if you have trouble starting or operating your car, look for some simple cause, rather than failure of a major component. For instance: Loose battery connections are more likely than battery failure.

A loose ignition wire is much more likely than distributor, coil, or ignition system failure.

No fuel in the tank or foreign material in the fuel line is more likely than fuel pump or carburetor failure.

In many cases, car operating troubles are coupled with outside factors, such as climatic conditions, road conditions, change of servicing or fueling source or change of drivers.

Car troubles that occur as a result of normal use and wear usually give plenty of advance

warning. These troubles usually result from overlooking specified regular maintenance services. Whenever car performance seems less than normal in any category, it is best to consult with your Ford dealer at the first symptom, rather than wait until a serious problem develops. One of the aims of Ford Quality Car Care is to help you under just these circumstances.

if engine won't crank

1. Check the Fordomatic Selector lever operation. The starter will operate only when the lever is at N or P. Apply the brakes and try moving the lever slightly right or left of the "N" position. If engine will then crank, have your Ford dealer adjust the safety switch linkage.
2. Switch on the headlights. If the lights go out when the key is turned to "Start," the battery connections may be loose or the battery discharged.
3. Another indication of loose battery connections or low battery condition is a stutter-

ing noise from the engine compartment when the ignition switch is turned to start. This noise comes from the starter solenoid switch and indicates low voltage to the starter. Check the connections to the starter motor and the solenoid switch in addition to the battery connections.

4. Try operating the starter switch several times. Should the switch be corroded, this operation may clean the contacts or make the switch temporarily operable until you can reach your Ford dealer.
5. If all the electrical connections are tight and you need assistance to start, read the instructions on page 24 under Pushing and Towing.

if engine cranks but won't start, check:

1. Fuel gauge. You may be out of gas. If the gauge shows that there's fuel in the tank, the trouble may be in either the ignition system or the fuel system.
2. Ignition System. To check for trouble in the ignition system, remove the wire from

one of the spark plugs by grasping the moulded cap of the wire only, and insert a short piece of bare wire or other metal object in the terminal of the wire. Then hold the wire insulation so that the bare wire is about 3/16 inch from the engine block and crank the engine for at least 3 seconds. If there's no spark between the wire and the metal, the trouble may be in the distributor or coil. If you see a spark, then check the fuel system for trouble.

3. Check the manual choke. The choke linkage may be binding or damaged so that the choke plate in the carburetor is not opening and closing properly. When the choke knob on the instrument panel is pulled out, the plate should close. The choke plate should be opened when the knob is pushed in. You can check this, with the engine stopped, by removing the carburetor air cleaner and looking into the carburetor air intake.

if engine runs hot

The following items could cause an engine to overheat:

- Lack of coolant
- Late ignition timing

- Loose fan belt
- Dirty cooling system
- Prolonged idling
- Driving car with a frozen coolant
- Defective thermostat
- Overloading or pulling heavy trailers during hot weather

if car steers hard

This can be caused by low air pressure in the tires, by misalignment of the front wheels, or low fluid level in steering assembly.

if brakes do not grip well

1. If you have been driving through deep water, gently apply the brakes several times as the car is moving slowly.
2. Let the brakes cool if you have been using them abnormally, as in mountain driving or after several fast, high speed stops.

if steering wanders or pulls at high speeds

This condition can be caused by . . .

- Soft tire(s) on any wheel(s)
- Wheels out of line, or balance

- Steering gear preload needs adjusting
- Car overloaded or unevenly loaded
- High winds
- High crown in center of road

if fuses burn out

Burned-out or "blown-out" fuses usually indicate an electrical short-circuit, although a fuse may occasionally fail from vibration. Insert a second fuse. If this fuse immediately burns out, and you cannot locate the cause, return your car to your Ford dealer for a circuit-check.

if lamp bulbs burn out

Repeated lamp burn-out usually indicates a loose connection, either at the lamp socket or the system ground. If examination does not indicate the cause of the trouble, return your car to your Ford dealer for inspection.

if headlamps flash off and on

If headlights begin to flash off and on at regular intervals, the system circuit breaker is operating, indicating a short circuit or overload. Take your car to your Ford dealer for a circuit-check.

PUSHING AND TOWING

If your car is equipped with an automatic transmission, *it should not be started by pushing or towing*. Use a booster battery or jumper cables from the battery in another car. Connect positive terminal to positive terminal, and negative to negative. Remove the air cleaner and check to see that the choke plate is fully closed.

If you have a manual-shift transmission, it can be started by pushing. Place the shift lever in high gear before being pushed, and keep the clutch pedal fully depressed. Then, with the ignition switch ON, slowly release the clutch pedal when the car's speed reaches 10 mph, and press the accelerator pedal half-way down until the car starts moving under its own power.

If your car must be towed, it is important that the towing chains be fastened only to the arms or brackets that attach the bumper to

the underbody. The chains must be routed under the bottom edge of the bumper. Make sure the parking brake is released and the gear selector is in the neutral position. It is important to know that the transmission and rear axle are in proper working order before towing. To move a car with an inoperative axle, it is necessary to raise the rear wheels. If the transmission is inoperative, the drive shaft must be removed, or the rear wheels raised, whichever is more convenient. Caution: If a car is to be towed with the rear wheels raised, a locking device should be installed to hold the front wheels in a straight ahead position.

If your car must be towed with the rear wheels on the ground, do not exceed 30 mph, nor a distance of 15 miles. If the above speed or distance has to be exceeded, it is best to disconnect the drive shaft.



INSTRUMENTS, CONTROLS, CONVENIENCE FEATURES

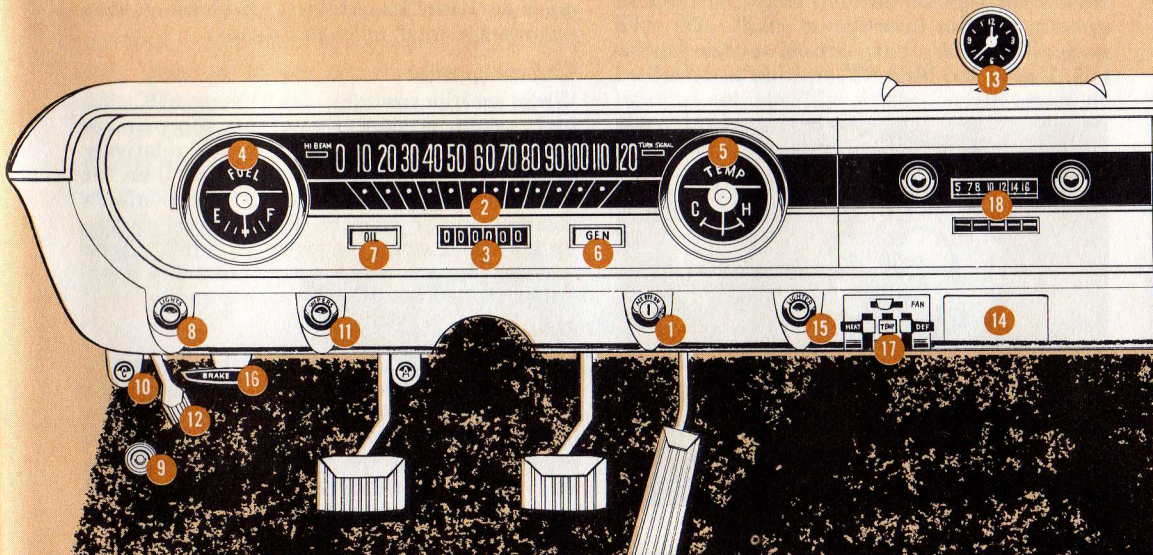

	See Page
1 Ignition Switch	26
2 Speedometer	26
3 Odometer	26
4 Fuel Gauge	26
5 Temperature Gauge	26
6 Generator Indicator	27
7 Oil Pressure Indicator	27
8 Light Switch	27
9 Headlight Beam Selector	28
10 Choke	28
11 Wiper Control	28
12 Washer Control	28
13 Clock	29
14 Ash Tray	29
15 Cigar Lighter	29
16 Parking Brake	30
17 Heater Controls	38
18 Radio	42

INSTRUMENTS AND CONTROLS

keys

Two different keys operate all the various locks of your car. A shield-shaped key locks and unlocks either front door, as well as the ignition switch. The round-headed key is used in the deck lid lock.

Having two keys enables you to allow the car to be operated—in a parking lot or service station for instance—while you retain control of the security of any items you may have locked in the luggage compartment.

Attached to these keys are metal rings on which code numbers are stamped. For extra keys or quick replacement at any Ford dealership—and most locksmiths—keep these rings, or the record of these code numbers. There is a space on the inside front cover of this manual for your key numbers to be recorded.

1 ignition switch

This 4-position switch to the right of the steer-

ing column is operated by the shield-shaped key. The ACC (accessory) position permits use of electrical accessories that are controlled through the switch. Only the ignition system remains inactive at ACC. To turn on ignition and other circuits, set the key at ON. Use of the START position is described on page 50.

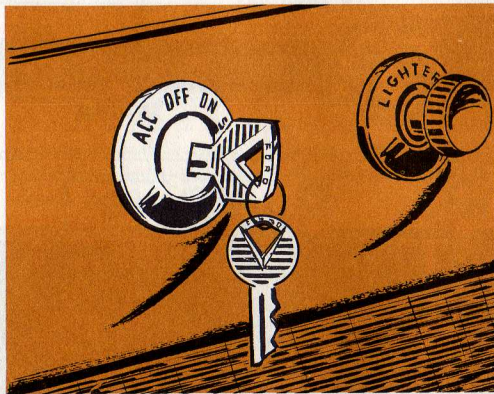

2 3 speedometer and odometer

The speedometer, located above the steering column indicates the car's forward speed in miles per hour. The odometer (mileage gauge) records the total mileage driven.

4 fuel gauge

When ignition switch is at ON or ACC, the fuel gauge pointer shows an approximate gasoline level. The pointer moves relatively faster from F to three-quarters full than for the remainder of its travel. The pointer's position varies slightly during acceleration, braking, and when the car is on a hill. Check fuel supply when the car is reasonably level, either standing still or moving steadily.

5 temperature gauge

For most types of driving, the temperature gauge pointer hovers on the curved line in the center range of the gauge, indicating a normal operating temperature. Overheating is indicated only when the pointer moves all the way to the H (Hot) mark or beyond, and remains there for more than a minute or two.

6 generator indicator

With ignition switch on, the GEN indicator light, to the right of the steering column, glows red when generator is not supplying current to the electrical system. GEN light may glow or flicker occasionally as engine idles. However, if the light remains on steadily at normal driving speeds, generator and electrical system should be checked as soon as possible.

7 oil pressure indicator

Should the engine's oil pressure drop below a safe operating limit, the OIL indicator light to the left of the steering column, glows red. The OIL light may flicker briefly after a sudden stop or at idle, but this is not necessarily harmful to the engine. However, if the light glows steadily when engine speed is above idling, stop the engine immediately and have the oil level checked. **DO NOT DRIVE THE CAR WITH THIS LIGHT GLOWING STEADILY.**

8 light switch

Pull LIGHTS knob outward to its first position. This turns on parking lights and taillights. At the second position, headlights and taillights are on. At either position, the instrument panel lights can be dimmed, brightened, or turned off by rotating the knob. To switch on interior light, turn the LIGHTS knob all the way to the left, either pushed in or pulled out.

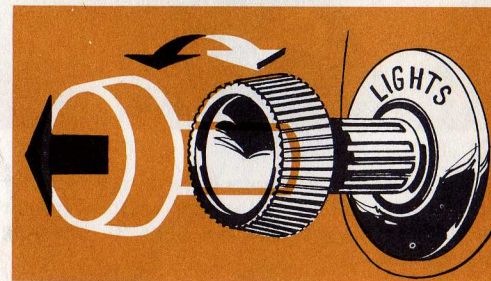

9 headlight beam selector

Two sets of headlight beams meet varying night driving conditions. Generally, low beams provide adequate light: high beams give better long-range visibility on dark roads. When the headlights are on, press the beam selector button, located on the floor to the left of the steering column, with your left foot to change from one set of beams to another. A small red indicator light near the center of the speedometer dial glows whenever the high beams are being used.



10 choke

The manual choke control, used on 6-cylinder models, enriches the engine fuel mixture for cold weather operation. See page 50 "Starting the Engine."

turn indicator selector

To signal for a right turn, push turn indicator lever upward. For a left turn pull lever downward. Flashing lights on the front and rear of the car and the instrument panel indicate the direction you intend to turn, with the left light flashing for an intended left turn and the opposite for a right turn. If the turn is very gradual, the indicator may not shut off when you straighten the wheel. If this occurs, merely move the lever to the neutral position by hand.

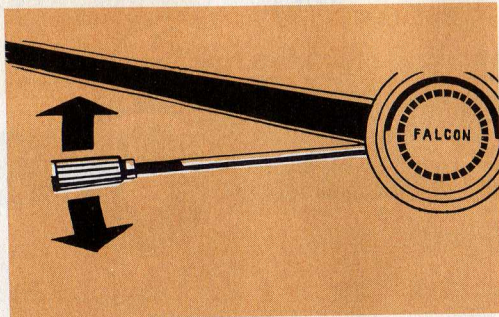

11 12 wiper and washer control

Rotate wipers knob clockwise to turn on wipers. Standard wipers are single-speed electric. Optional electric wipers have two speeds. Turn the knob all the way to the right for high speed. The pedal for the optional windshield washer is at the left front corner of the floor. Press the pedal to spray the windshield with fluid. If the wipers are stopped, they'll automatically start moving and will continue to sweep across the glass as long as you hold the pedal down.

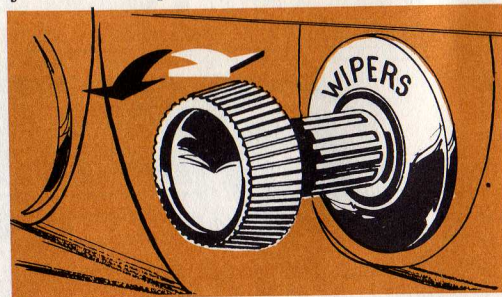

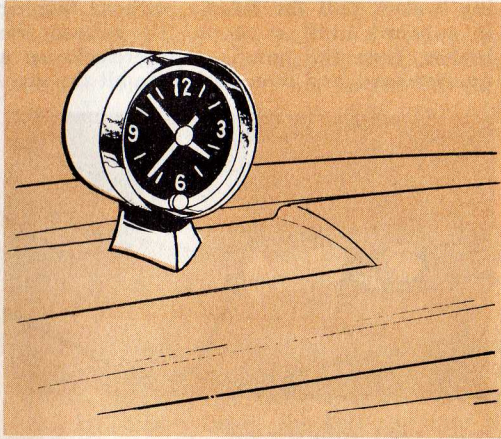

13 clock

In the self-regulating electric clock there is a special mechanism for automatically correcting time gain or lag up to a limit of five minutes per 12 hours. Once regulated, the

clocks tends to stay regulated. In setting the clock, you advance the hands toward the correct time if it is slow, and backward to the correct time if it is fast. If the error is large—say five minutes—the first setting may reduce the error to one minute or less. A second setting, or a third if necessary, should put the clock right on time.

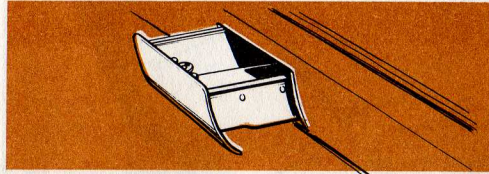

You should adjust any inaccuracy when you first get your car; ignoring it only multiplies the time needed for adjustment later.

14 ash trays

The instrument panel ash tray is opened by pulling outward on the tray bottom front edge. To remove it for cleaning, open the tray and gently press down on front of tray while continuing to pull outward. To install the tray,

place the tray into the opening, aligning the slides and push in.

To remove the rear seat ash tray on 4-door models, depress the snuffer and pull tray out. On 2-door models, open the cover and lift tray assemblies from the arm rest.

15 cigar lighter

Push the LIGHTER knob in all the way. When it is hot, the lighter will automatically pop out to its normal position.

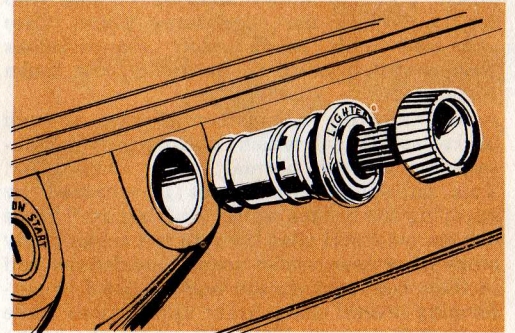

horn

The horn is sounded by pressing the horn button or ring on the steering wheel.

gear shift lever

The gear shift lever operating instructions are contained on pages 52 through 55.

foot pedals

Brake pedal is under steering column and to the left of the accelerator pedal. Cars equipped with manual-shift transmissions have a clutch pedal to the left of the brake pedal.

A self-adjusting mechanism is part of each brake assembly, which automatically compensates for the normal brake lining wear. This automatic adjustment is obtained by applying the brakes while "backing up." Some drivers may find that they do not make many stops in reverse under normal conditions and in their case they should make a point of performing several sharp brake applications while moving in reverse. This will set up the brake

shoes to the correct adjustment.

If further brake adjustment is necessary, see your Ford dealer.

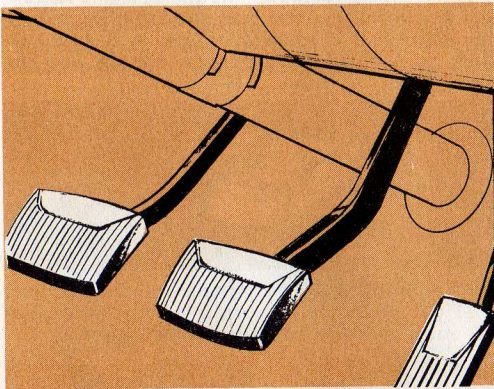

16 parking brake control

The BRAKE handle is beneath the left end of the instrument panel. To apply the park-

ing brakes, pull the handle, without turning it outward until it stops. To release the brakes, turn the handle counterclockwise a quarter turn, and then push it in all the way.

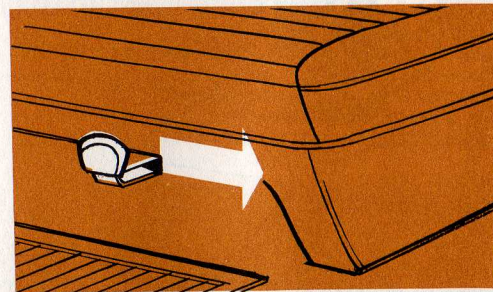

front seat adjustment

In cars equipped with full-width front seats or bucket seats, a control lever on the left front edge of the seat releases the seat latch. To move the seat forward or back, push the lever to the left and hold it as you slide the

seat to the desired position. Release lever to lock the seat in place.

The bucket seat back angle can be adjusted. Two seat back stops, located on the bottom edge of the seat back, can be screwed in or out. The seat back will be more erect when the stops are lengthened. Adjust both stops to the same length.

seat belts

Two types of seat belts are available. Before fastening a front seat belt, adjust the driver's seat. For greater safety and comfort, be sure the belt is snug and not twisted.

metal-to-metal. To lengthen the metal-to-metal belt, tip the buckle end downward, as shown, and pull the buckle until the belt ends can be joined. Insert the belt end into the open end of the buckle until a snap is heard. This belt can be shortened, after it is connected, simply by pulling on the loose end until the belt is snug. Lift the buckle release to remove the belt.

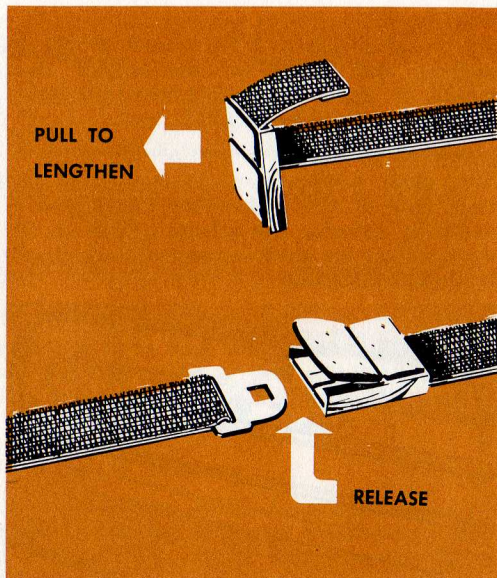

metal-to-web. To connect the metal-to-web belt, lift the buckle release and insert the belt end through the buckle as shown. This belt is adjusted by drawing the loose web end through the metal buckle until snug. To release this type belt, lift the buckle release and remove the belt.

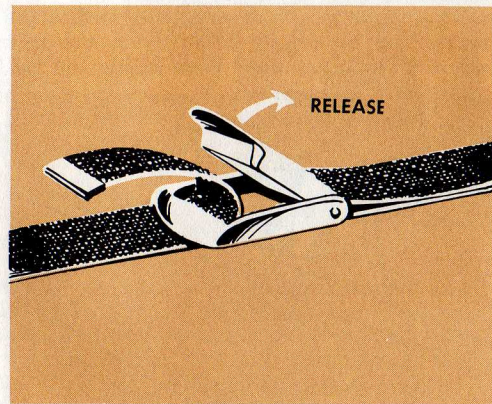

STATION WAGON FEATURES

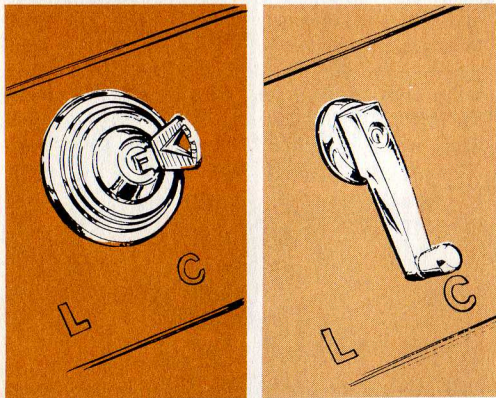

manually operated tailgate window

The window must be opened or closed from outside the tailgate. To unlock the tailgate handle, turn the key in the tailgate lock one-

fourth turn to the right. The window must be cranked up or down after you've unlocked the handle. To lock the window at any position (open, partially open or closed), turn the key counterclockwise while the handle knob is in the vertical bottom position.

power operated tailgate window

The electric tailgate window is controlled by a switch on the left side of the instrument panel next to the LIGHTS switch. For maximum safety, the ignition switch must be either "ON" or in the "ACC" position before the window can be operated. If you prefer full-time operation, your Ford dealer can provide this by a simple wiring change. You can also open or close the tailgate window by turning the key in the tailgate lock, and holding it until the window reaches the position you desire.

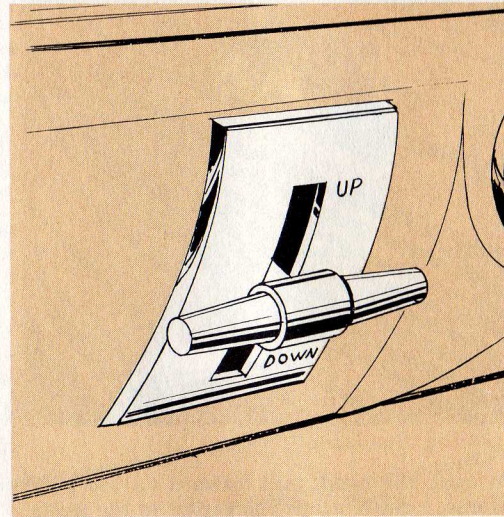

tailgate opening

Open the tailgate window as previously described. With the window fully opened, reach inside the station wagon and pull the tailgate release handle knob upward to unlock it, then push the release handle to the right. Pull the tailgate down all the way.

tailgate closing

Before closing the tailgate, be sure the window is all the way down. *Don't close the tailgate with the window even partially raised.* Lift the tailgate up and push it forward firmly. Be sure the tailgate is fully forward and latched so that the glass aligns with its guides. Push the tailgate release handle down to lock the tailgate.

station wagon second seat

To fold down the Station Wagon rear seat to provide additional floor space, pull the back edge of the cushion upward, and pull the cushion support rod around to the front. Then swing the cushion toward the front seat so that the support rod rests on the floor. Release the safety catch at the upper right corner of the seat back, and lower the seat back into the cushion opening to form a flat surface.

When you're ready to use the rear seat again, lift the seat back out of the cushion opening, and push it back to its upright position. Be sure the safety catch is fully engaged to keep the seat back from falling forward if the car should stop suddenly. Swing the cushion rearward, and clip the support rod firmly under both ends of the cushion.

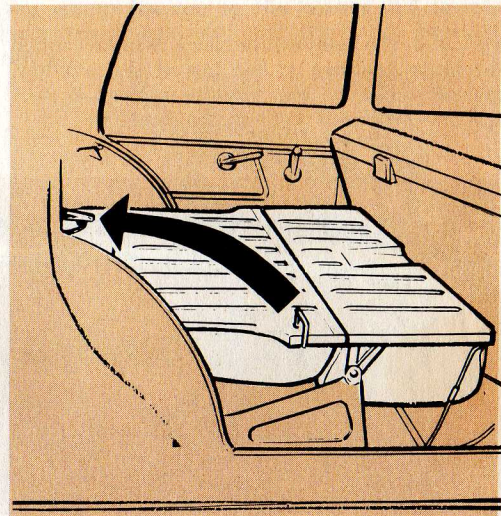

CONVERTIBLE FEATURES

opening and closing the back window

To open the convertible back window, open the slide fastener at the top of the window, and carefully lay the window in the top storage compartment behind the rear seat.

To close the rear window, lift the corner of the window into position, aligning the slide fastener ends and run the other hand firmly against the side edge of the window. (This will seal the top and the window edge together.) Repeat the procedure for the other corner of the window. Close the slide fastener at the top—it may be necessary to unfasten the windshield header clamps to ease tension on the slide fastener.



lowering the top

The convertible top can be lowered with the back and side windows either up or down. However, to cut down unnecessary wear on the back window, it is better to have it open before the top is lowered. Unclamp the top from the windshield header by pulling the two clamp handles downward until their ends are clear. If the top has not been lowered for some time and sticks to the header, push the

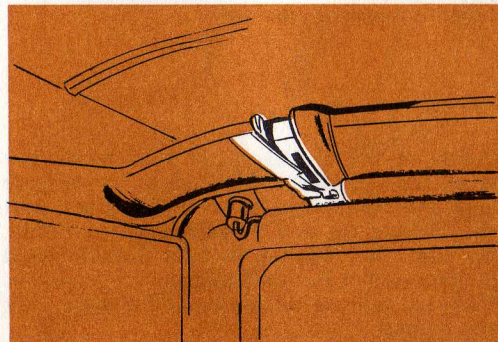

front of the top up slightly with your hand to loosen it. Check the storage compartment behind the rear seat to be sure it is empty and ready to receive the top. Push down on the TOP toggle switch control, located at the left end of the instrument panel, holding it until the top folds down completely. Don't lower the top while the car is moving or if the top material is wet. After the top is fully lowered, cover it with its vinyl boot to keep out dust and dirt.

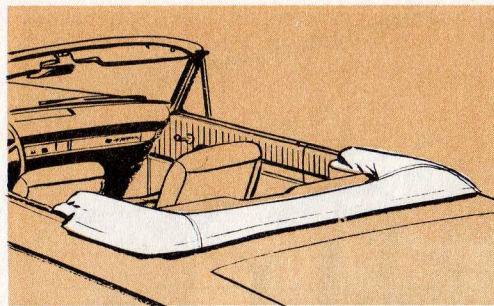
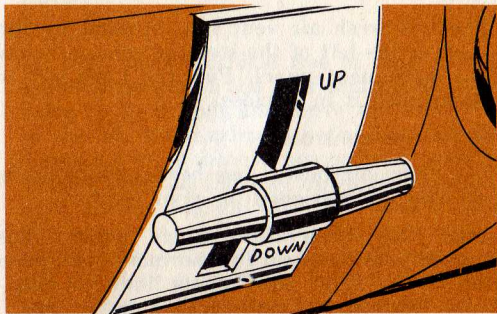

raising the top

Pull both sun visors downward and partially lower all the side windows so they won't interfere with the forward movement of the top. Then remove the vinyl boot covering and store it in the protective envelope. Don't raise the top while the car is moving. Lift the TOP toggle switch control, holding it until the top unfolds and moves forward against the windshield header. The two pins under the for-

ward edge of the top should seat themselves in the matching holes in the header. If you want the back window closed, close it before you clamp the top to the header. To fasten both clamps securely, push the clamp handles upward.

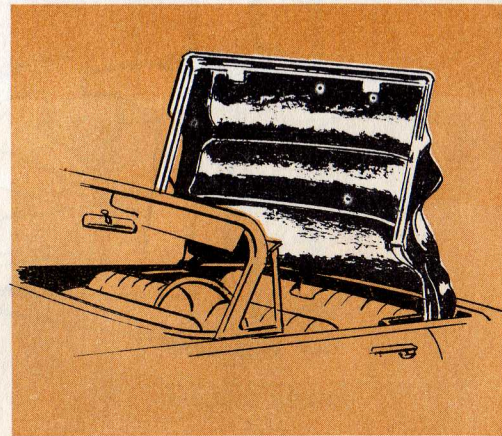

VENTILATING AND HEATING

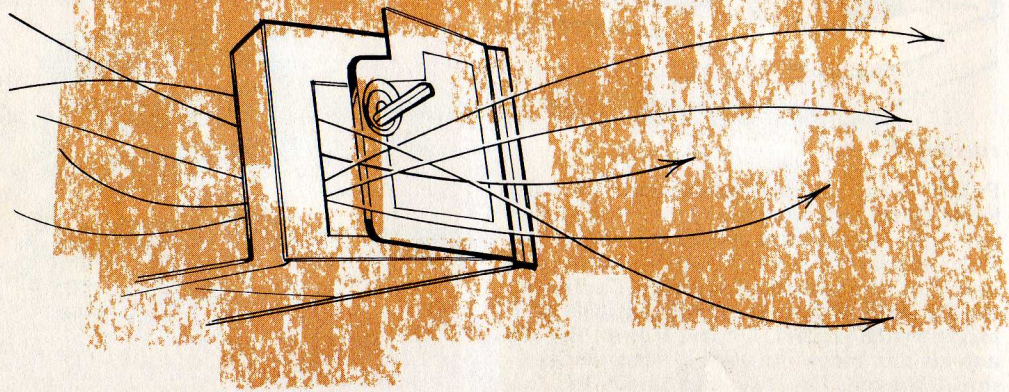

ventilating controls

Fresh air ventilating doors are located under both ends of the instrument panel and they can be opened to allow outside air to enter the car for warm weather ventilation. The heater controls should be in the OFF position to allow air thru the right air ventilator. The door on the right must be closed and latched (turn the door handle to latch it) to keep cold air from entering the car when you are using the heater.

The left fresh air vent is controlled by the knob at the left of the steering column below the instrument panel. Pull the knob out to open; push it in to close.

17 heater controls

The fresh air heater has been painstakingly planned and designed for your comfort.

After the temperature gauge pointer has started to move toward its normal range, push the HEAT lever down to its limit for maximum fresh air through the heater.

Push the TEMP lever down to its limit for maximum heat. Turn the FAN switch to the left for high blower or to the right for low blower depending upon how much air you want the fan to blow into the car.

At moderate high driving speeds, the fan may not be needed because the car's forward motion will force outside air through the heater and into the car for your comfort.

defroster controls

To keep the windshield free of light frost or condensation, push the DEF and HEAT levers down to their limit and move the FAN lever to the left for maximum defrosting. For fast defrosting or to remove heavy frost, push the TEMP lever all the way down for maximum heat. By moving the HEAT control lever all the way down and the DEF control lever to any position between the top and bottom, you can circulate some of the heated air through the defroster and some into the car at the floor level.

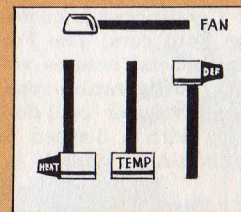
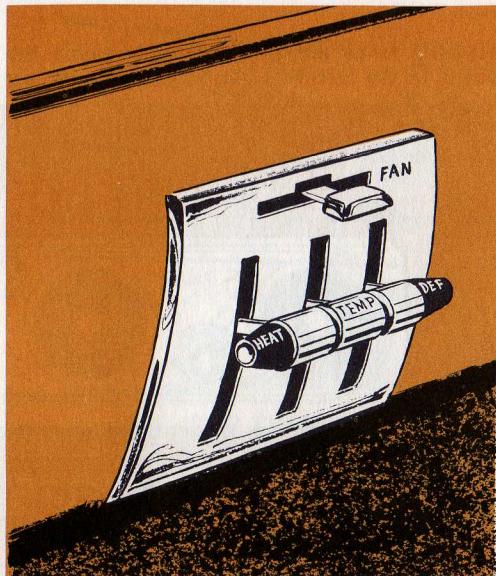

MAXIMUM HEAT

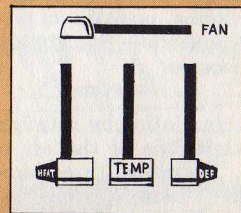

MAXIMUM DEFROST

Ford air conditioner

The Ford Air Conditioner is custom-designed exclusively for Ford cars. The Ford crest on the chrome-finish bezel assures you that this is a top-quality, refrigeration-type air conditioner. It provides faster cool-down, greater cooling capacity with a 3-speed blower, and efficient de-pollinating action.

For temperature control, start the engine and rotate the TEMP knob on the right of the air conditioner control panel from the OFF position to the cooling position of your choice. The farther you rotate the knob, the cooler the air will become.

Control of air circulation by rotating the FAN knob, on the left side of the air conditioner control panel. There are three blower speeds to choose from . . . low (1), medium (2), and high (3). The farther you rotate the knob, the higher the blower speed. To control the four

movable front air outlets, simply point the outlet in the direction you wish to aim the air

stream. The side outlets can rotate 360° to circulate the cool air to individual preference.

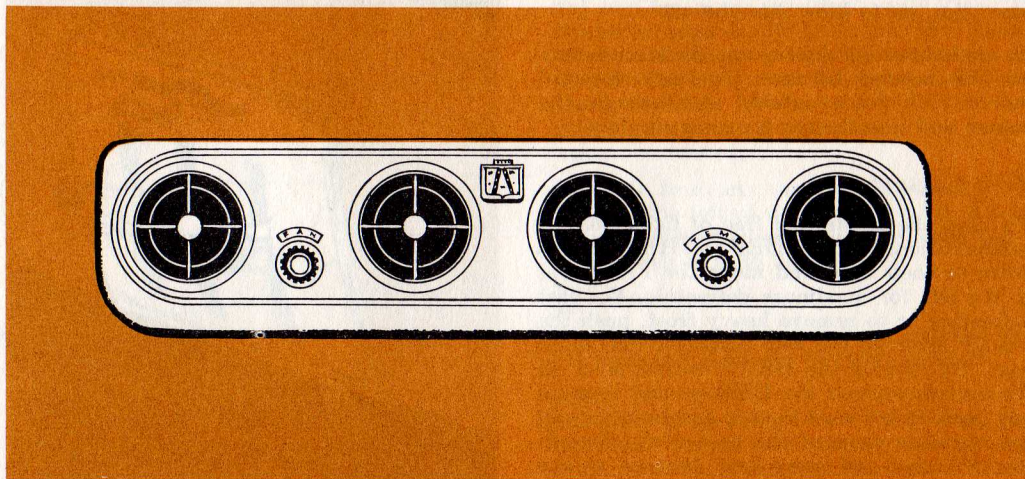

TIPS FOR BETTER AIR CONDITIONING

Though your Ford air conditioner has a more rapid cool-down rate, it helps, when starting out in hot weather, to set temperature control at 5 (maximum cooling) with the fan on. Then drive for two or three minutes with the side windows and both fresh air registers open to force most of the hot air out of the car. Then, close the windows and both air registers, and turn blower to desired speed.

Operate your air conditioner cooling system regularly. At least once or twice a month turn on the cooling control and blower for a few minutes while the engine is running. This periodic operation keeps all the mechanical parts of your air conditioner in good operating condition.

Each spring have your Ford dealer make a pre-season inspection to be sure your air conditioner is ready for efficient operation. He'll check the cooling system for refrigerant state of charge and leaks, and add the specified refrigerant and compressor oil, if required.

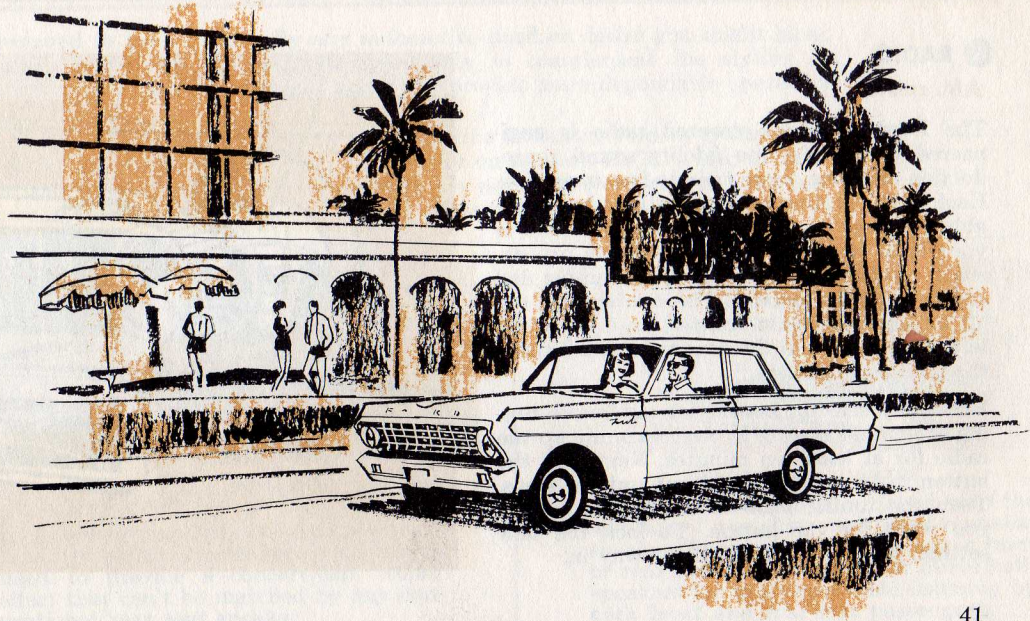

18 RADIO

AM radio

The Ford transistor-powered radio is engineered to provide fine fidelity sound reproduction and long, more trouble-free operation. Each of the station selector buttons has probably been set by your Ford dealer to one of your local stations. If other stations are desired, the knob at the right of the tuning dial can be turned manually. The combination on-off switch and volume-control knob is at the left of the dial, and the tone control is behind the volume knob.

Reset any selector button for automatic tuning of another station by first warming up the radio for at least ten minutes. Next, pull the button to be reset straight out until it stops. Turn the tuning knob to the station setting you want for the button. To lock the new setting, push the button all the way in.

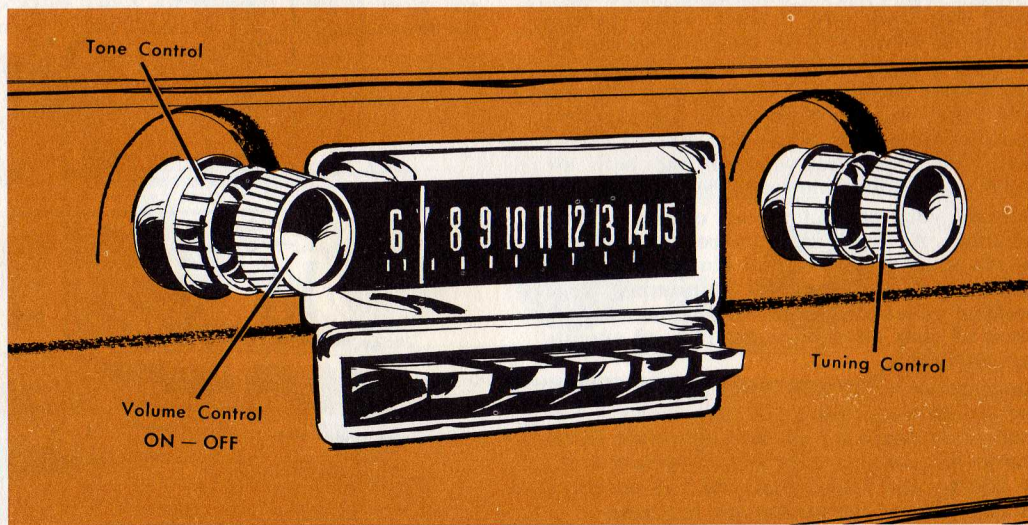



/ Want to personalize your new FALCON?

There's a Ford quality accessory designed to meet practically any automotive need or desire you might have. These Genuine FoMoCo and Rotunda accessories are designed specifically to complement the styling of your Falcon, and are manufactured to Ford's high standards of quality to provide more dependable operation and longer life.

The following pages review briefly Ford's line of quality accessories. Full line accessory folders giving more detailed information on Ford accessories are available from your Ford dealer on request. He'll be glad to show you his complete line of accessories, and to explain how his low, competitive prices on Ford accessories make it easy for you to own them. *Of course, if installation is required, he's in a position to provide the best.*

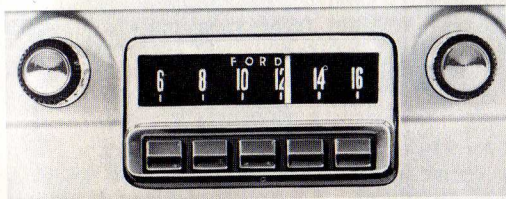

Push Button Radio

Fully transistorized AM radio with large 5" x 7" speaker provides instantaneous and clear extended-range reception. A new, radio-noise suppression feature minimizes distortion, providing only the finest tonal fidelity.

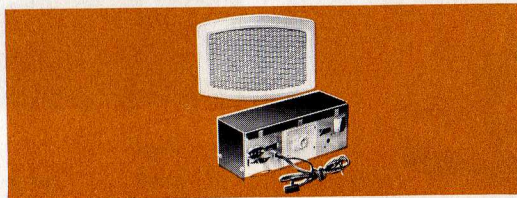

StudioSonic Sound System

Reverberator in rear seat works in conjunction with the speaker in the radio itself to provide a concert-hall "echo" effect that can't be matched by any conventional rear seat speaker.

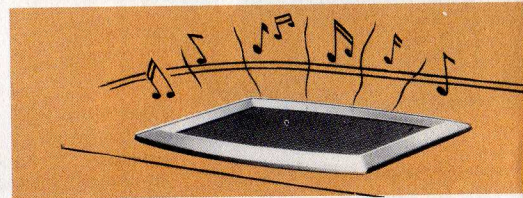

Rear Seat Speaker

Sound reproduction is enriched with the addition of a quality-engineered rear-seat speaker. Three-way control tunes in front or rear speaker separately, or mixes both speakers for more enjoyable listening by both front and rear-seat passengers.



1964 ACCESSORIES / for unsurpassed Beauty and Utility

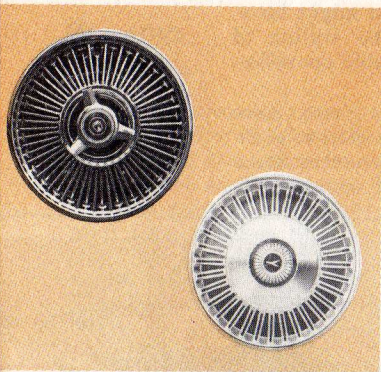

Wheel Covers

Gleaming stainless steel wheel covers add an attractive styling detail that definitely enhances the appearance of your new Falcon. Deluxe or distinctive simulated-wire wheel designs are available at a very moderate cost.

Ventilated Seat Cushion

Inner springs and open mesh fiber combined in one individual cushion give you a "breezy bucket seat" that permits fresh, cool air to circulate between you and the seat. Available in four attractive colors.



Plastic Seat Covers

Heavy duty, clear plastic seat covers protect upholstery without hiding colorful decorator fabrics. Spots and spills wipe off with a damp cloth. Available for both front and rear seats.

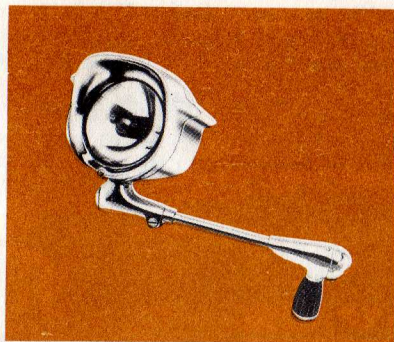

Spotlight With Mirror

Powerful, sealed-beam reaches out over one-half mile in clear weather. Head rotates full 360°. Has built-in, full-view "First Surface Glass" mirror. Provides greater driving convenience and safety, night or day.



Rubber Floor Mats

Durable, easy-to-clean, long-wearing rubber. Choice of eight harmonizing colors. Front, contoured, door-to-door or individual front twin mats . . . and individual twin rear mats.

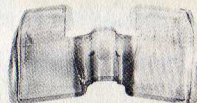

Clear Vinyl Floor Mats

Let attractive carpet colors show through while protecting carpeting from wear. Front contoured, door-to-door and individual twin rear mats. Can be cut to custom-fit all models, including those with a center console.



1964 ACCESSORIES/for GREATER SAFETY



Outside Rear View Mirrors

A wide variety of distinctive chromed "first-surface" glass mirrors are available to suit your driving needs. They have positive-friction ball swivels to maintain mirror position and avoid vibration misalignment.



Back-up Lights

Twin lamps, centered in tail-lights, light your way at night for safer, easier backing. Also warn others behind you when you are backing up, even in daytime. Light automatically when your Falcon is put in reverse.

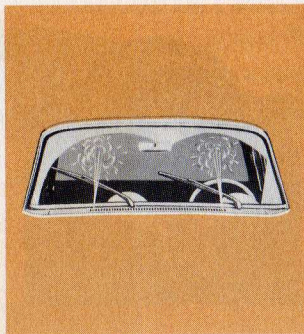

Windshield Washers

Twin jets of washer solution sprayed on your windshield enable wipers to clean off hard-clinging road film in seconds . . . thus reducing eye strain and fatigue. Required by safety laws in many states.

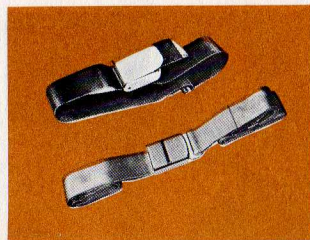

Seat Belts—Metal-To-Webbing and Metal-To-Metal Buckles

Ford quality seat belts meet all requirements of the Society of Automotive Engineers and General Services Administration. Made of strong nylon webbing to withstand 5,000 pounds of sudden pressure. Instantly releasable with one hand. Available in 7 harmonizing colors.



Parking Brake Warning Light

If brake is set, a bright red, jeweled light starts to blink on and off as soon as the engine is started. Warns driver immediately and helps prevent unnecessary brake wear.



1964 ACCESSORIES / for greater Driving Convenience

Power Brakes

Falcon power brakes, available on Fordomatic-equipped models, provide faster, surer straight-line stops. Reduce pedal effort up to 55% over regular hydraulic brakes. Vacuum reserve permits three normal stops even in the event the engine stops.



Power Steering

Falcon power steering reduces steering effort up to 85%. Simplifies parking and reduces fatigue of driving, particularly at lower speeds in traffic. Regular mechanical steering takes over if power system becomes inoperative.

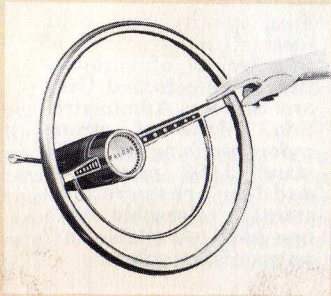

Self-Regulating Electric Clock

Precision clock mounts on top of the dash. It features sweep-second hand and illumination of dial for easy reading at night.

Remote-Control Rear View Mirror

This mirror offers the ultimate in beauty, safety and convenience. A toggle switch, conveniently mounted on the door panel, controls the viewing angle of the mirror and permits easy adjustment from within the car. The mirror is mounted and moves within a sturdy metal frame. Once positioned, it seldom requires adjustment.

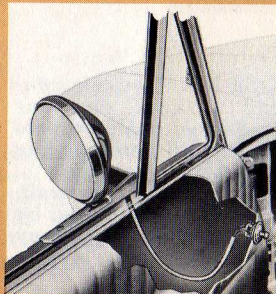

Tachometer

This precision instrument measures exact engine revolutions per minute. Helps you obtain maximum engine performance by indicating the most efficient gear shift points. A valuable aid in engine performance evaluation and tune-up. Available in 3 and 4 inch models for both 6 and 8 cylinder engines.





1964 STATION WAGON ACCESSORIES

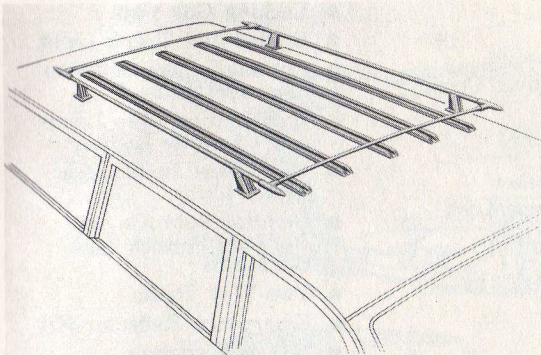

Bright Metal Luggage Rack

This attractive aluminum and chrome rack will support up to two hundred and fifty pounds of cargo. Its low-silhouette adds a distinctive appearance to the Falcon station wagon. The luggage carrier is 55" long by 43" wide by 4" high.



Luggage Rack Cover

This extra strong, water-resistant, black-vinyl-coated cover provides dependable cargo protection. Special, weather-sealed, heavy-duty zipper permits easy access on 3 sides.

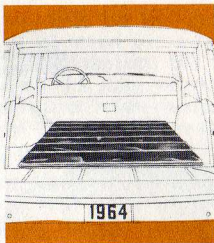

Home and Travel Pad

Sturdy, washable vinyl covering with comfortable fibre filler. Ideal for converting the rear deck into a comfortable play area for children. Convenient for beach, camping or poolside. Available in 3 colorful, two-tone combinations.

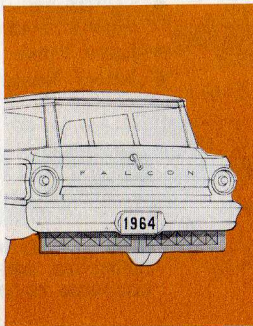

Mud and Stone Deflector

This functional, full-width deflector, which is made of heavy-duty rubber, protects the bumper and finish from tire spray and helps keep the rear window clean for added driving safety.



Rear Window Screen

This fine-mesh, aluminum screen and frame can be installed in the rear window in seconds, providing protection for passengers and cargo plus maximum ventilation. Pays for itself again and again in added comfort, convenience and safety.



/ Here are more **QUALITY ACCESSORIES**

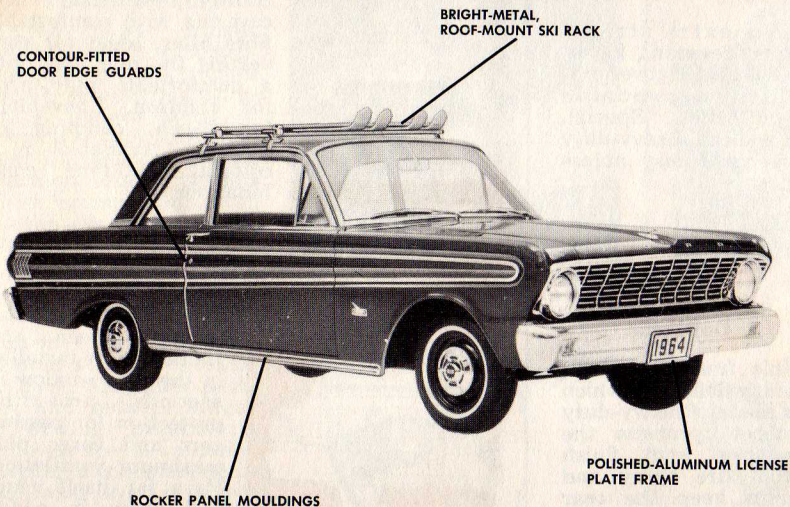

- Air Conditioner (See Page 40)
- Cigarette Lighter
- Convertible Tonneau Cover (Cloth)
- Windshield-Mounted Compass
- Door Storage Pocket
- Glove Compartment Lock
- Remote Control Deck Lid Release
- "Lifeguard Jr." Rear Door Safety Locks
- Lake Pipes
- Litter Basket
- Locking Gas Cap
- Engine and Trunk Light
- Automatic Transmission Selector Light
- Combination Map Lamp and Cigarette Lighter
- Non-Glare, Inside Rear View Mirror
- Genuine FoMoCo and Rotunda Polishes and Chemicals
- Two-Way Radio
- Emergency Reflector Kit
- Tissue Dispenser
- Tool Kit



FORD QUALITY ACCESSORIES ARE DESIGNED, ENGINEERED AND FACTORY TESTED TO MEET FORD'S HIGH PERFORMANCE STANDARDS AND TO CONFORM TO THE STYLING OF YOUR 1964 FALCON.

VEHICLE OPERATION

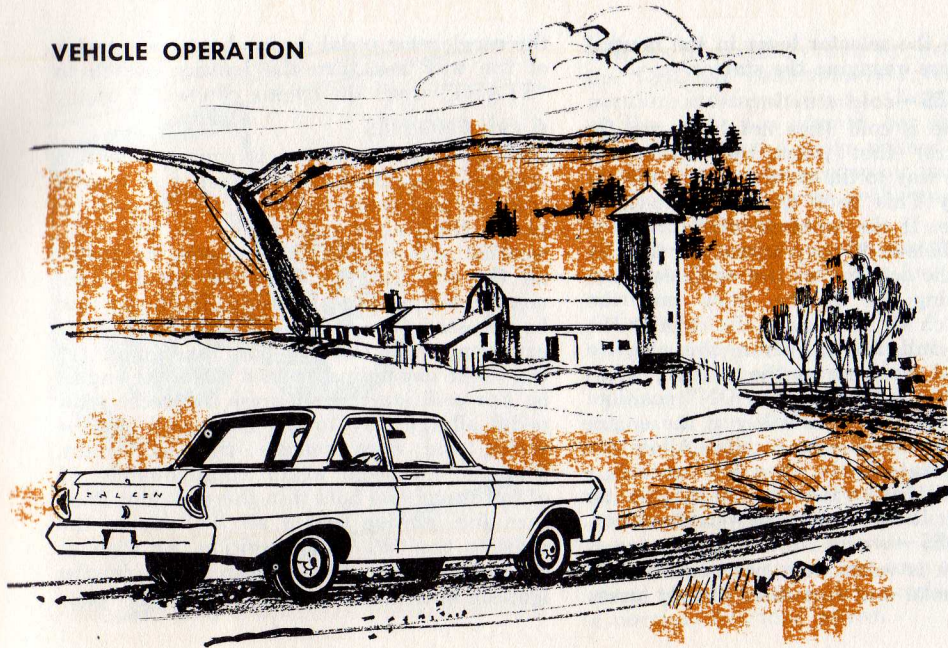

the first few miles

Your new car was ready for the road the moment you took delivery. There is no need for a long, tiresome, low-speed break-in period. Nevertheless, it's best to get your car off to a good start toward a long, economical life. By observing a few simple operating rules during the first few hundred driving miles, you can experience the maximum in new-car performance, economy, and durability.

Remember during the first 250 miles, to avoid sudden, hard stops. The brakes seat more uniformly if you make slow, gradual stops from various speeds.

Avoid fast starts at wide-open throttle. And, after starting a cold engine, drive slowly until it warms up. Otherwise, any reasonable speed within legal limits is permissible.

Up to 500 miles, deliberately vary the speed from fast to slow and back again, if traffic conditions don't do it for you automatically.

Any steady, unchanging speed during this period tends to cause uneven wear of precision parts. Accelerate up to 60 mph when you can. In fact, one- or two-mile spurts at legal speeds above 60 are fine. Any legal speed short of wide-open throttle is all right up to the 2,000-mile mark. Keep away from top speeds until you've driven the car at least 2,000 miles.

STARTING THE ENGINE

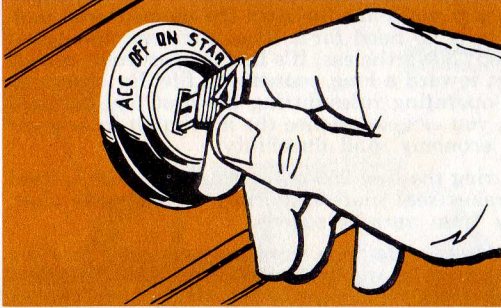

Be sure your garage door is open **WIDE** before you start or run the engine. Exhaust gases contain poisonous carbon monoxide which will build up to a dangerous level within minutes in any enclosed space.

With any automatic transmission, the range selector lever must be in "P"ark or "N"eutral position before the starter will engage. With a manual transmission, it is good safety prac-

tice to place the selector lever in the neutral position before engaging the starter.

V-8 ENGINES—cold starting

If the engine is cold (has not been run for several hours) first press the accelerator pedal all the way to the floor and then release it all the way. This "sets" the automatic choke and fast idle. If the ambient temperature is +10°F. or below, it may assist starting by depressing the accelerator two or three times before starting the engine. Now turn the ignition switch all the way to the right to the "START" marking. When the engine "catches" and runs, release the ignition switch and it will spring back to the "ON" position. The fast idle mechanism will run the engine a little faster than normal idle. Allow the engine to operate freely for a few seconds, a sharp tap with your foot on the accelerator pedal will let it return to a slower idle speed.

V-8 ENGINES—warm starting

If the engine is warm, it is not necessary to "set" the choke and fast idle. Simply press

the accelerator pedal down about one-quarter of the way and turn the ignition switch to "START" until the engine catches.

6 cyl. ENGINES

The six cylinder engine is equipped with a manually operated choke which you control from a pull-push knob on the instrument panel. Starting a cold engine in very cold weather will require the choke to be pulled all the way out. On the other hand, if the outside temperature is above 70° it may not be necessary to use the choke at all. A little experience will tell you how far to pull out the choke depending on how warm the engine is. For cold starting, depress the accelerator pedal all the way to the floor, pull out the choke, and then release the accelerator. Depress the pedal again approximately $\frac{1}{4}$ of full travel and hold it in this position. Then turn the ignition switch all the way to the right to the "START" position. As soon as the engine runs under its own power, let the ignition switch spring back to the "ON" posi-

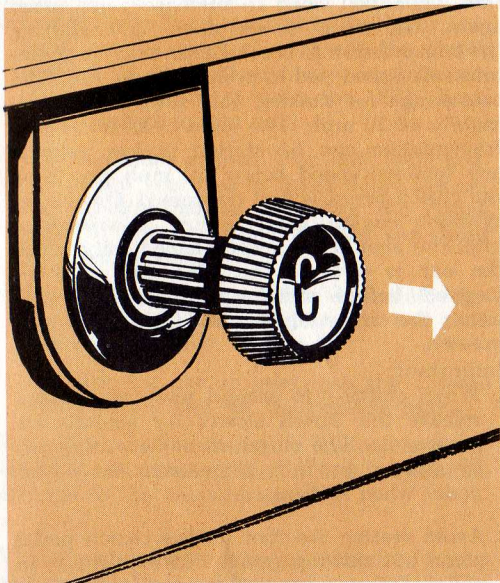

tion. As the engine warms up, gradually push the "CHOKE" control back in. When the temperature indicator moves up from the "C" end of the dial, you should be able to drive normally with the choke pushed all the way in. For best gasoline economy, push the choke control in just as soon as the engine will run normally without it.

To start a warm engine, depress the accelerator pedal slightly and turn the key to the start position.

FLOODING

If the accelerator is pushed all the way to the floor when starting a warm engine or is "pumped" excessively when starting a cold engine, it is possible to "flood" the engine (inject too much gasoline). If the engine turns over but will not fire, or if you smell gasoline, this is probably what has happened. In this case, press the accelerator all the way down and hold it there while you crank the engine with the starter. As soon as the engine starts to run, let up on the accelerator to hold a normal "fast idle" speed.

If the engine does not start within 30 seconds, turn the ignition switch back to "OFF" and wait a few moments before cranking the engine again. This procedure will conserve your battery power and extend the life of your battery.



DRIVING WITH MANUAL TRANSMISSION

3-Speed

This transmission is synchronized for up and down shifts between second and high gears with six cylinder engines and fully synchronized in all forward gears with eight cylinder engines. The shift pattern is the familiar "H." With the engine running and the car at a standing position with the shift lever in neutral, depress the clutch pedal fully to the floor board and move the shift lever to first

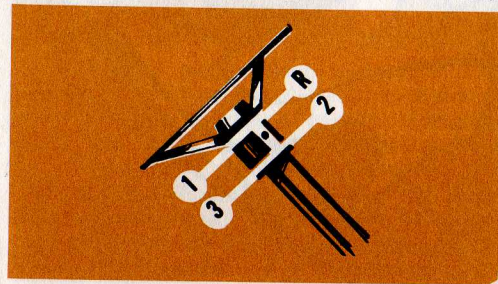

gear. Depress the accelerator slowly, at the same time releasing the clutch. Drive to a speed of approximately 15 mph, release the accelerator pedal, depress the clutch pedal fully again to the floor board and move the shift lever through the neutral position to second gear. Release the clutch pedal (fully in up position) and accelerate to approximately 30 mph, release the accelerator pedal, depress the clutch pedal fully and shift to third gear, release the pedal and accelerate to the desired speed.

To stop the car, release the accelerator pedal and apply the brake. Do not depress the clutch pedal until the car speed is reduced to approximately 10-15 mph. Depress the clutch while applying the brake to come to a complete stop.

When it is necessary to reduce speed in heavy traffic, or when driving up steep hills in third gear, downshift to second gear before the engine starts to labor (40-20 mph). Such downshifting reduces the possibility of stalling the engine and gives better accelera-

tion when you need to increase your speed again. On steep downgrades, downshifting the transmission to second gear helps to maintain safe speed and to prolong brake life. The best range for making this shift is approximately 40-20 mph. The eight cylinder engine transmission can be shifted to low gear at any forward speed below 20 mph providing the clutch pedal is first depressed. On the six cylinder engine transmission, downshifting into low should be accomplished only when the car is *not* moving. The car must be stopped before shifting into reverse with either the six or eight cylinder engine transmission.

Important:

1. When shifting to second and third gears, release the clutch slowly for smooth engagements. The clutch must be completely disengaged by fully depressing the clutch pedal when shifting.
2. Avoid resting the foot on the clutch pedal when not shifting gears. This can result in clutch failure.

3. Six-cylinder engine: When shifting the transmission from neutral to first gear (car must not be moving), depress the clutch pedal fully to the floor board, hesitate momentarily before moving the shift lever from neutral to low gear.

Eight-cylinder engine: The shift from neutral to low gear can be made while the car has forward motion providing the clutch pedal is first depressed and the car speed does not exceed 20 mph.

4. When downshifting, always downshift high to second and then to low. Do not shift directly from high to low.

5. To park the car in gear, use the reverse gear position and set the parking brake.

Failure to observe the above instructions will result in unnecessary clutch wear or possible damage to the transmission.

4-speed

This transmission is fully synchronized for up and downshifts in all forward gear ratios. The

shift pattern is shown on the knob of the floor-mounted shift lever. The crossbar at the center of the shift pattern represents the neutral position in which the car has neither forward nor reverse motion under its own power.

Use the same technique described for 3-speed transmissions to shift from one gear to another. To engage reverse, bring the car to a complete stop, depress the clutch pedal and position the shift lever in neutral. With the clutch pedal depressed, lift upward on the finger operated safety-release lever mounted below the shift lever knob; then, move the shift lever to the extreme left and push the shift lever forward. Release the finger operated safety-release lever; then, release the clutch pedal. *Do not shift into reverse when car is in motion.*

When it is necessary to reduce speed in heavy traffic, or when driving up steep hills in fourth gear, downshift to third, second or first gear before the engine starts to labor. Such downshifting reduces the possibility of stalling the engine and gives better acceleration

when you need to increase your speed again. On steep down-grades, downshifting the transmission helps to maintain safe speed and to prolong brake life.

The best range for downshifting from fourth to third gear is 55-25 mph, third to second gear is 35-15 mph, and second to first gear 20-0 mph. Always downshift in sequence, that is, fourth to third, third to second, and second to first. It is not recommended to skip a gear ratio or to downshift at speeds greater than shown above.

Failure to observe the above instructions will result in unnecessary clutch wear or possible damage to the transmission.

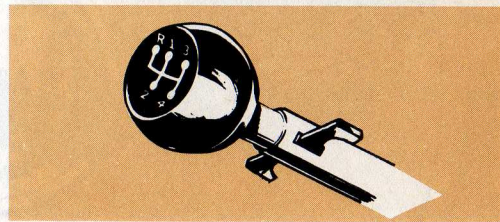

DRIVING WITH FORDOMATIC

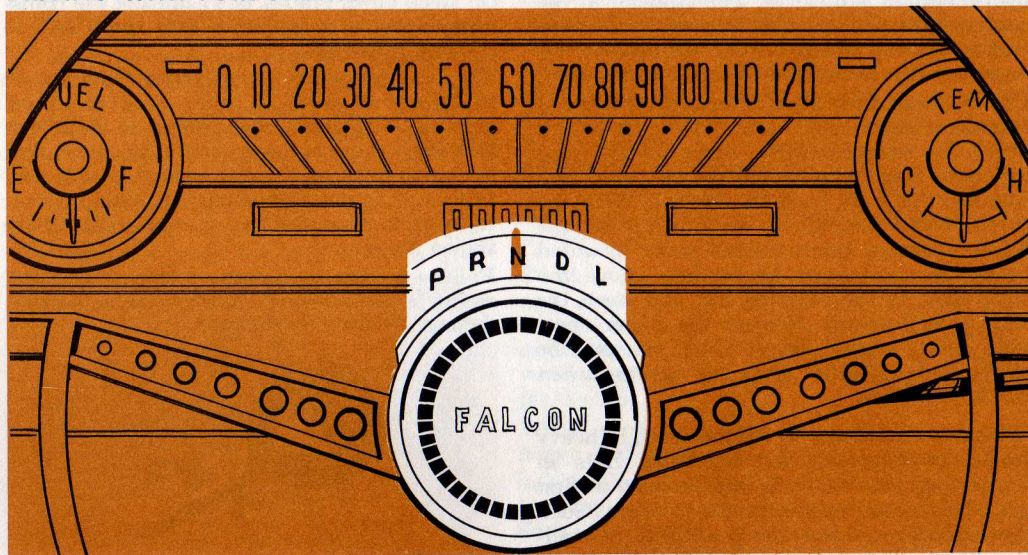

The two-speed Fordomatic transmission has five positions in which the transmission can be shifted; "P" (Park), "R" (Reverse), "N" (Neutral), "D" (Drive) and "L" (Low). These positions are shown on the indicator dial located on the steering column.

to go forward

To meet all driving conditions, low-cost Fordomatic Drive, famed for economy of operation, offers one versatile drive range with two forward speeds. With the selector lever at D, press down on the accelerator pedal, as needed to start the car moving in low gear. At the right speed for the driving conditions, the transmission automatically upshifts to high gear. You can get fast car-passing acceleration or extra hill-climbing power speeds between 15-55 mph without shifting the lever from D. Press the accelerator pedal to the floor and hold it for a downshift to low gear.

The "L" (low) position is useful for driving in mud, sand, or deep snow, and for braking

or climbing action on steep downgrades. In "L," Fordomatic will always operate in low gear regardless of the car's speed. If you should shift from "D" to "L" at any road speed, the transmission immediately downshifts to low gear. Do not shift to or drive in "L" at speeds over 55 mph. Do not shift into forward gear while the car is moving backward.

to go backward

Shift the selector lever to "R" (reverse) only when the car is fully stopped. Then press the accelerator pedal down lightly and carefully.

to park the car

With the car fully stopped, apply the parking brakes, then shift the selector lever to "P" (park). This selector position locks the rear wheels and the transmission, even with the engine running. Park position should never be used to stop the car.

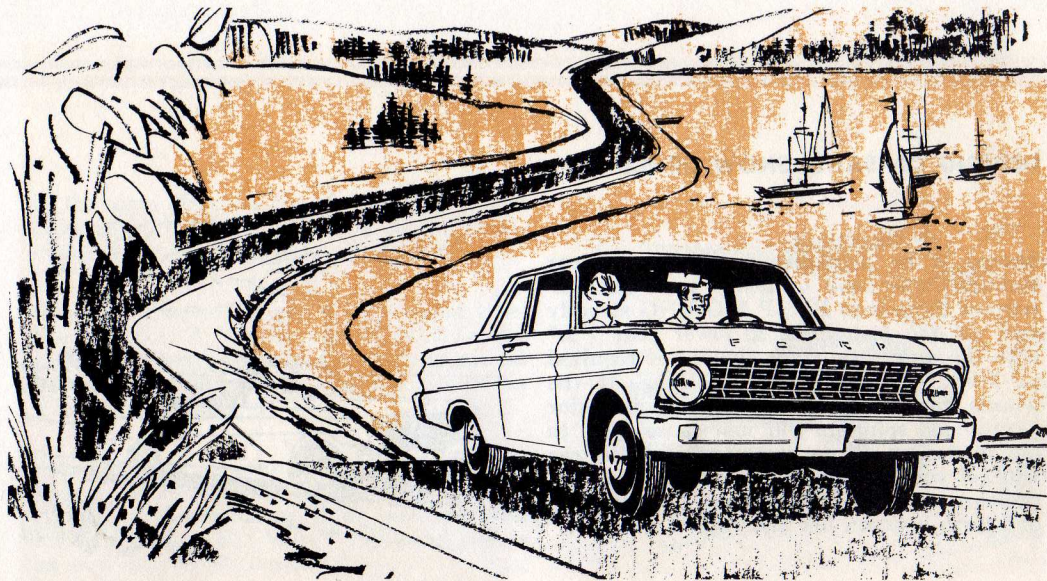

DRIVING ON SAND, SNOW OR ICE

Should it be necessary to drive your car through loose sand or heavy snow the important thing is to **KEEP MOVING** steadily and not too fast. Shift to lower gear ("L" with the automatic transmission) if required to keep the engine from laboring. If the wheels start to spin, let up on the accelerator—continued spinning will just cause them to dig in deeper. Sometimes "rocking" the car will get you moving. To do this, hold a light pressure on the accelerator and shift back and forth between low and reverse gear ("L"



and "R" with automatic transmission) timing the shift to build up a rocking motion of the car. If you are still stuck after a minute or two of rocking, better have the car pulled out to avoid overheating and possible damage to the transmission.

When driving on slippery or icy surfaces, avoid any sharp stops, starts, or turns. Think ahead to avoid situations where you will have to make any sudden maneuvers. When you need to stop, pumping the brake pedal gently will sometimes avoid skids. In starting off use intermediate or high gear and accelerate gently. If you do skid, turn the wheels gently

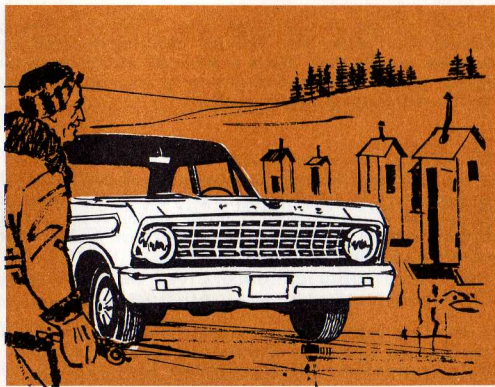

in the same direction you are skidding. If you have room, a **LIGHT** pressure on the accelerator may help straighten you up.

Snow tires or chains often help where traction is poor. A bag or box of sand in the luggage compartment (and a scoop to spread it with) will frequently help you out of an annoying situation.

Avoid driving through flooded areas unless you are sure the water is no higher than the bottom of the hub-caps. Shift into low gear and go through **SLOWLY**. Try your brakes as soon as you get across.

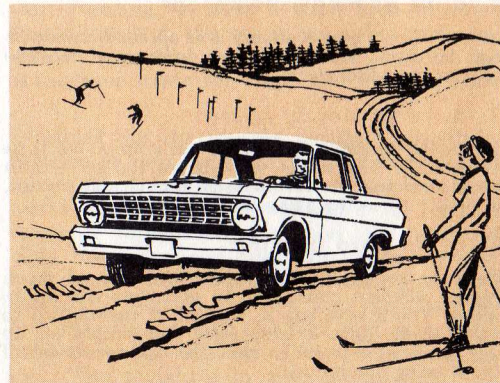

FOR BEST ECONOMY

1. start gradually, accelerate gently

Jack-rabbit starts and sudden bursts of speed are the main causes of excessive fuel consumption in ordinary driving. By accelerating more slowly, you'll need less power and gasoline to move the car the same distance.

2. drive at moderate speeds

Your Falcon's best economy is at speeds between 35 and 60 mph. The faster you drive your car, the greater your fuel costs.

3. drive at steady speeds

Wherever possible, vary your car's speed as little as possible. The driver who jiggles the accelerator pedal, moving the car in little bursts and pauses, is simply throwing away nickels and dimes.

4. avoid hard braking

Each brake application means the loss of much energy already consumed to get your car up to speed. You'll save gas if, instead of rushing up to a red traffic light or stop sign, you simply let up the accelerator pedal so that the car does most of the slowing down itself.

5. shut off ignition when parked

An idling engine uses a richer mixture to prevent stalling. And since the car is not moving, the gasoline used is wasted. If you don't mind a slightly "rough" idle, idling speed adjustments slightly below normal will sometimes help.

6. tire pressures

Keep tires up to recommended pressures. In fact 4 to 6 pounds extra pressure will improve economy—especially when carrying heavy loads—if you don't mind slightly "harder" riding qualities.

7. cooling system

The 185-195 degree thermostats installed in your car at the factory usually provide better fuel economy than the 160 degree thermostats used with alcohol-base antifreeze

8. carburetor accelerating pump

Adjust pump linkage to the leanest setting that will give the desired acceleration characteristics under prevailing climatic conditions. A slight sacrifice in acceleration can pay dividends in economy

9. ignition timing

Have your Ford dealer set your ignition timing at the specifications that suit the conditions under which you drive. He can "tailor" both the initial and automatic advance characteristics of your distributor to suit your driving conditions and the fuel you normally use.

10. choke

If your car has an automatic choke, use the leanest setting that gives you reliable starting in existing climatic conditions. With a manual choke, remember to push the control knob in as soon as the engine will run normally without it.

11. carburetor

If you will be driving mostly at altitudes over 3,000 feet above sea level and/or if you don't mind a slight loss of performance, your dealer can install slightly leaner jets in your carburetor which will improve gasoline economy.

12. keep your car in condition

Have your Ford dealer regularly perform the Ford Quality Car Care maintenance operations called for on the coupons in the back of this book.

OPERATION IN EXTREMELY COLD WEATHER

Your car battery is your best friend in extremely cold weather. Have the cells checked with a hydrometer at regular intervals and if the reading is below 1.250 specific gravity, have it charged. It is also a good idea to turn off your headlights when the engine is shut off or is idling. This prevents drain on the battery. Remember that the battery works overtime during the long hours of winter darkness. A little care will be more than repaid in satisfaction and reliability.

When parking your car overnight, leaving it inside a garage, even if not heated, will prevent wind-chill and make morning starting much easier. Since a 10W-30 oil is used at the factory, changing to a lighter grade engine oil (see lubrication specifications) also makes the starting easier under these conditions.

When starting, if the engine fires but does not keep running, "pumping" the accelerator

a few strokes sometimes provides the extra fuel needed to get it going. Be careful, however, too much "pumping" can "flood" the engine.

Whenever possible, it is good practice to let the engine run for a few minutes to warm up before you put it in gear and move off. Even light oils are more sluggish when very cold and this gives the oil time to circulate to all the vital moving parts of the engine. When you drive away, take it easy at first because the lubricants in the transmission and axle are cold too, and need time to circulate.

Check your anti-freeze protection regularly and watch the temperature indicator. Any sudden rise in the reading may indicate a freeze-up somewhere in the cooling system. Do not put cardboard or cloth in front of the radiator to get higher temperatures. If the temperature does not come up after a few miles of driving, have your Ford dealer check the thermostat.

Frost on the outside glass surfaces is best scraped off with a plastic scraper. If the windshield wiper blades are frozen to the glass, free them gently to avoid damage to the rubber blades. In very cold weather, even the best windshield washer solvents will not prevent freezing, so it is a good idea to carry paper towels in the car to wipe dirt and road splash from the glass, especially where salt is used on roads for snow and ice clearance.

Washing the car in cold weather sometimes gets water into locks and push-button latches where it will freeze and prevent the lock from working. The best preventative for this is frequent application of a good lock lubricant (like Rotunda Lock Lubricant) into keyholes and around push buttons. If your lock does freeze-up, heating the key with a match before inserting it into the lock will sometimes help thaw the lock out. Don't blow into the lock. The moisture in your breath will just freeze it tighter.

SPECIFICATIONS

identification

The car warranty number and other important identification information is stamped on the warranty plate, which is attached to the rear face of the left front door. The official serial number for registration purposes is stamped on the body in the engine compartment.

approximate refill capacities

	U. S. Measure	Imperial Measure
Fuel Tank (except V-8 Station Wagon).....	13½ gallons	11¼ gallons
V-8 Station Wagon...	19½ gallons	16¼ gallons
Engine Cooling System		
6-cyl.*.....	9½ quarts	8¼ quarts
8-cyl.*.....	14½ quarts	12 quarts
*Includes 1 quart for heater.		
Engine Crankcase		
6-cyl.†.....	4½ quarts	3¾ quarts
8-cyl.†.....	5 quarts	4¼ quarts
†Includes 1 quart required for filter replacement.		
Transmission		
3-speed—6-cyl.	2½ pints	2 pints
8-cyl.	3½ pints	3 pints
4-speed—6-cyl.	4½ pints	3¾ pints
8-cyl.	3¾ pints	3 pints
Fordomatic.....		
6-cyl.	7½ quarts	6¼ quarts
8-cyl.	8¾ quarts	7¾ quarts
Rear Axle		
6-cyl.	2½ pints	2 pints
8-cyl.	4½ pints	3¾ pints

general dimensions

Wheelbase.....	109.5 inches
Tread—Front—6-cyl.....	55 inches
—8-cyl.....	55.6 inches
Rear.....	56 inches

Overall Length—	
Sedan and Convertible.....	181.7 inches
Station Wagon, Sedan Delivery, and Ranchero.....	190.9 inches
Overall Width.....	71.6 inches

engines

	144 CID Six	170 CID Six	200 CID Six	260 CID V-8
Bore (Inches).....	3.50	3.50	3.68	3.80
Stroke (Inches).....	2.50	2.94	3.13	2.87
Taxable Horsepower.....	29.4	29.4	32.5	46.2
Brake Horsepower.....	85 @ 4200 rpm	101 @ 4400 rpm	116 @ 4000 rpm	164 @ 4400 rpm
Torque (Foot-Pounds).....	134 @ 2000 rpm	156 @ 2400 rpm	175 @ 2400 rpm	258 @ 2200 rpm
Fuel Requirement.....	Regular	Regular	Regular	Regular
Compression Ratio.....	8.7 to 1	8.7 to 1	8.7 to 1	8.7 to 1
Firing Order.....	1-5-3-6-2-4	1-5-3-6-2-4	1-5-3-6-2-4	1-5-4-2-6-3-7-8
Spark Plugs:				
Ford Part Number.....	B7A-12405-B	B7A-12405-B	B7A-12405-B	B8A-12405-A
Replacement.....	(Autolite BF-82)	(Autolite BF-82)	(Autolite BF-82)	(Autolite BF-42)
Spark Gap Width.....	0.032-0.036 inch	0.032-0.036 inch	0.032-0.036 inch	0.032-0.036 inch
Distributor Point Gap.....	0.024-0.026 inch	0.024-0.026 inch	0.024-0.026 inch	0.014-0.016 inch
Ignition Timing†				
Std. Transmission.....	8°*	6°*	—	6°
Auto. Transmission.....	12°*	—	12°*	10°

*Ignition timing requirements may vary depending upon locality, fuel, and operating conditions. For best economy and performance, the timing may be advanced to a point just short of audible detonation under load but not to exceed 5° over normal setting.

†Do not retard the initial advance beyond 2° BTDC for sub-standard fuels.

fuses (12 volts)

Circuit	Location	Fuse Number
Radio.....	Fuse Panel on Lights Switch	SFE-7.5
Instrument Lights...	Fuse Panel on Lights Switch	1AG-2 or AGA-2
Turn Indicator and Back-up Lights...	Fuse Panel on Lights Switch	SFE-14
Heater Fan.....	Fuse Panel on Lights Switch	SFE-14
Lights		
Parking, Rear, Rear License, and Dome	Fuse Panel on Lights Switch	3AG-15 or AGC-15
Air Conditioner.....	Cartridge in Power Feed Wire	3AG-15
Spotlight.....	Cartridge in Power Feed Wire	SFE-7.5
Emergency Warning Flasher.....	Same as Above	SFE-14

battery (12 volts)

Standard Battery	
6-cyl. 40* Ampere-hours.....	54 plates
*200 CID 55 Ampere-hours.....	54 plates
8-cyl. 55 Ampere-hours.....	54 plates
Taxi 55 Ampere-hours.....	66 plates
Optional Heavy-Duty Battery	
6-cyl. 55† Ampere-hours.....	54 plates
†200 CID 65 Ampere-hours.....	66 plates
8-cyl. 65 Ampere-hours.....	66 plates

circuit breakers

Circuit	Location	Rating
Headlights.....	In Lights Switch	12 amp.
Windshield Wiper Motor—		
Single Speed.....	Edge of Instrument Panel—Left of Steering Column	5 amp.
2-Speed.....	Same as Above	12 amp.
Electric Tailgate Window.....	On Starter Relay	20 amp.
Convertible Top.....	On Starter Relay	20 amp.

lights (12 volts)

	Wattage or Candlepower	Lamp Number
Headlights.....	50-40 watts	6012
Parking and Front Turn Indicator.....	32-4 cp	1157A
Stop, Tail, and Rear Turn Indicator.....	32-4 cp	1157
Back-Up.....	32 cp	1156
Rear License Plate.....	4 cp	1155
Dome Lamp.....	15 cp	1003
Courtesy Light (Convertible).....	6 cp	631
Radio Dial.....	2 cp	1891
All instrument panel bulbs, unless otherwise indicated..	2 cp	1895

tire pressures

	Pounds per Sq. In. (Cold)*	
Sedan and Convertible.....	Front 24....	Rear 24
Station Wagon, Ranchero and Sedan Delivery.....	Front 24....	Rear 28†

*For considerable high-speed driving or heavy loads, add 4-6 pounds to recommended cold pressure.
†30 for 6-cylinder Ranchero or Sedan Delivery.

LUBRICANT SPECIFICATIONS

engine crankcase oils

oil viscosity

Use of SAE 10W-30 oil will provide the proper viscosity for all normal ranges of outside temperatures. For easier starting at sustained outside temperatures below -10°F . a 5W-20 oil should be used.

oil quality

Use only oils which have been tested and certified by the maker as satisfying automobile manufacturers specifications for Engine Operating Sequence Tests for Service M.S. Ford Motor Company specification covering these tests is M2C27. These tests are defined by ASTM committee D2 for Section G-IV of technical committee B and are published in the SAE Handbook.

These tests cover oil characteristics as follows:

Sequence I—Low Temperature Wear Prevention—(Cold Starts)

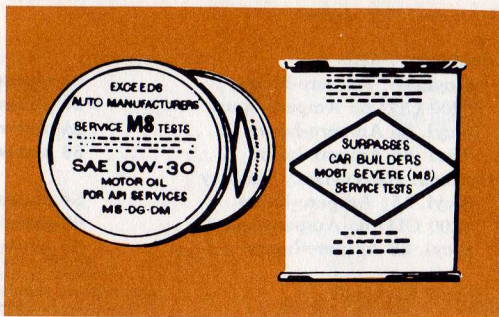

Sequence II—Corrosion and Rust Prevention

Sequence III—High Temperature Deposit Formation—(Varnish)

Sequence IV—High Speed—High Temperature Wear Prevention

Sequence V—Sludge Formation

If engine oils are used which do not meet these requirements, it will be necessary to change oil more frequently than every 6000

miles in order to insure satisfactory engine life and operation. Rotunda Oil Conditioner can be added to crankcase oils that do not meet the Ford specification. This will upgrade the oil to meet the engine operating sequence test requirements.

Use of the right oil filter is also essential to good engine life and operation. See page 5. For 6,000 mile filter change intervals, filters must meet Ford Specification ES-C0AE-6714-A.

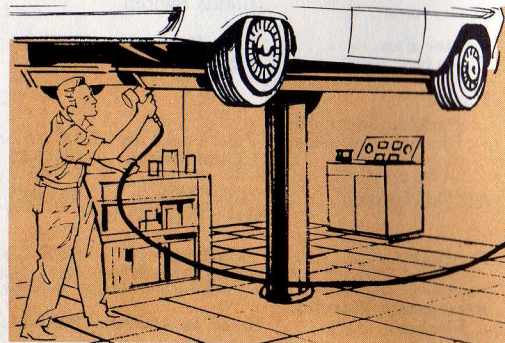

ITEM	FORD PART NUMBER	PART NAME	FORD SPECIFICATION	ALTERNATE LUBRICANT
Body Hinges	R113	Rotunda Silicone Lubricant	M-99C40-A or B	
Brake Master Cylinder	R103-A	Rotunda Heavy Duty Brake Fluid	M-3833-D	Alternate fluid must meet SAE J70B specification for 70R3 type extra heavy duty brake fluid.
Distributor Cam		Distributor Cam Grease	M-1C-66-A	Use a good high temperature No. 2 grade sodium soap grease.
Distributor Wick and Bushing		Engine Oil—SAE 10W		
Front Suspension Ball Joints	C1AZ-19590-B	FoMoCo Ball Joint Grease	M-1C47	Must meet Ford Specification
Front Wheel Bearings	C2AZ-19585-A	FoMoCo Wheel Bearing Grease	ESA-M-1C60-A	Must meet Ford Specification
Hood Latch and Safety Catch	R113	Rotunda Silicone Lubricant	M-99C40-A or B	Must meet Ford Specification
Lock Cylinders	R117-A	Rotunda Lock Lubricant	M-2C20-A	
Rear Axle	C 2AZ—19580-E	FoMoCo Hypoid Gear Lubricant	M-2C50 B*	Must meet Ford Specification
Steering Gear Housing (Manual or Power)	C3AZ-19578-A	FoMoCo Special Steering Gear Lubricants	ESW-M-1C87-A	Must meet Ford Specification
Steering—Power (Pump Reservoir)	R106-A	Rotunda Automatic Transmission Fluid	M2C33-C or D	‡‡
Convertible Top Reservoir	R106-A	Rotunda Automatic Transmission Fluid	M2C33-C or D	‡‡
Transmission (Automatic)	R106-A	Rotunda Automatic Transmission Fluid	M2C33-C or D	Only one quart of automatic transmission fluid marked "TYPE A, SUFFIX A" may be used to "add to" factory fill.
Transmission (Manual Shift)	R139-A	Rotunda Manual Transmission Lubricant	M-568-D	Reputable SAE 80 grade mild extreme pressure type lubricant can be used to "add to" factory fill.
Universal Joints	C1AZ-19586-B	FoMoCo Universal Joint Lubricant	M-1C57	Must meet Ford Specification

*For all cars equipped with Equi-Lock axles, use M-2C50-B, plus one ounce of M-2C58-A (Ford Part C1AA-19B546-A) additive per pint of M-2C50-B.

‡‡Automatic transmission fluid marked "Type A, Suffix A" may be used.

FORD QUALITY CAR CARE

The quality of maintenance your Falcon car receives is just as important as the regularity with which it is serviced. To provide greater nationwide uniformity of quality in customer service, your Ford dealer and the Ford Motor Company have cooperated in developing Ford Quality Car Care. One fundamental element of Quality Car Care is a national program of training for Ford Dealer Service Technicians, including both factory and dealer-sponsored schools. This Ford Training program is reinforced with a continuous follow-up of publications, slidefilms, charts and other service information, addressed directly to the Ford dealer, and averaging 4,000 printed pages a year. No other service organization can possibly have as complete and as correct a knowledge of servicing your Falcon as your Ford dealer and his Ford Service Technicians.

Other important factors contribute to Ford Quality Car Care. One is the use of only Genuine FoMoCo or Rotunda parts and/or accessories. The reputation of Ford Motor Company in precision manufacture is well-known. FoMoCo and Rotunda service parts and acces-

sories are built to the same high standards of precision and quality as original parts. Another factor is the use of Factory-designed or approved tools, developed and tested for the exclusive use of Ford Dealer Service Technicians.

However, as stated above, Quality Car Care includes both QUALITY and REGULARITY of service. Ford Motor Company, Ford dealers, and Ford Service Technicians provide the quality; it is up to you, as a Ford Registered Owner, to provide the regularity of service which is the other, equally important half of Ford Quality Car Care. Read over the Quality Car Care Coupons which follow, and familiarize yourself with the maintenance periods and operations. Make a point of bringing your car to your Ford dealer at the specified time or mileage intervals.

how to use Ford Quality Car Care coupons

As a Ford Registered Owner, you are the real Quality Car Care Manager for your car. The Ford Registered Owner Plan of twice-a-year maintenance was conceived to make it easy for you to meet the responsibilities of that position and to insure that your car will retain its value

and its "total performance" throughout the time that you will be driving it.

Use the Ford Quality Car Care Coupons on the following pages to make proper care as easy as driving your Falcon. Each 6 months or 6,000 miles, just fill out the appropriate Coupon, noting on it any extra work you would like performed, and take it and your car to your Ford dealer. As a Ford Registered Owner, you will receive courteous, preferential treatment and be charged reasonable and competitive prices. You will also have the satisfaction of quality workmanship, performed by factory-trained technicians, using factory-approved equipment and Genuine FoMoCo or Rotunda parts.

The certification by your Ford dealer on the reverse side of the stub of each Coupon will provide you with a permanent "Log Book" that will show you have MAINTAINED THE VALUE OF YOUR CAR AT A CONTINUOUSLY HIGH LEVEL BY HAVING ALL OF THE RECOMMENDED FORD QUALITY CAR CARE MAINTENANCE SERVICES PERFORMED AT THE APPROPRIATE INTERVALS.

**6,000-12,000 MILE
FORD QUALITY CAR CARE SERVICES**

1964 FALCON

	6,000	12,000
Change engine oil and install new Rotunda filter.....		
Clean carburetor air cleaner and filter.....		*
Clean crankcase oil filler breather cap.....		
Clean crankcase emission system.....		
Clean crankcase emission system tubes and filter.....		
Check transmission and axle lube levels.....		
Check brake master cylinder fluid level.....		
Check power steering fluid level.....		
Check steering gear preload.....		
Check ignition timing.....		

 Indicates not required at this mileage.

*State of California vehicles built after January 1, 1964, replace filter.

**12,000 MILE
FORD QUALITY CAR CARE
COUPON †**

1964 FALCON

I authorize performance of the services specified on the stub of this coupon. I understand that I will be charged \$_____ for this work. There will also be a charge for additional lubricants required.

Please also perform the additional services I have listed on the back of this coupon.

Date _____

Owner Signature

†Or 6 months (whichever occurs first) since 6,000 mile Quality Car

**6,000 MILE
FORD QUALITY CAR CARE
COUPON ***

1964 FALCON

I authorize performance of the services specified on the stub of this coupon. I understand that I will be charged \$_____ for this work. There will also be a charge for additional lubricants required.

Please also perform the additional services I have listed on the back of this coupon.

Date _____

Owner Signature

*Or 6 months whichever occurs first.

**6,000 MILE
FORD QUALITY CAR CARE
COUPON**

1964 FALCON

Additional services requested

64604
Points
Carburetor Kit.

**12,000 MILE
FORD QUALITY CAR CARE
COUPON**

1964 FALCON

Additional services requested

FORD QUALITY CAR CARE CERTIFICATION

This certifies that specified Ford Quality Car Care maintenance operations have been performed as indicated on the back of this stub. Additional work was performed as indicated below.

6,000 MILES

12,000 MILES

Date _____ Mileage _____

Date _____ Mileage _____

Dealership Name

Dealership Name

Dealership Address

Dealership Address

Signed

Signed

**18,000-24,000 MILE
FORD QUALITY CAR CARE SERVICES**

1964 FALCON

	18,000	24,000
Change engine oil and install new Rotunda filter.....		
Clean carburetor air cleaner and filter.....		*
Clean crankcase oil filler breather cap.....		
Clean crankcase emission system tubes and filter.....	■	
Clean crankcase emission system valve.....		
Check transmission and axle lube levels.....		
Check brake master cylinder fluid level.....		
Check power steering fluid level.....		
Check ignition timing.....	■	

■ Indicates not required at this mileage.

*State of California vehicles built after January 1, 1964, replace filter.

**24,000 MILE
FORD QUALITY CAR CARE
COUPON ‡**

1964 FALCON

I authorize performance of the services specified on the stub of this coupon. I understand that I will be charged \$_____ for this work. There will also be a charge for additional lubricants required.

Please also perform the additional services I have listed on the back of this coupon.

Date _____

Owner Signature

‡Or 6 months (whichever occurs first) since 18,000 mile Quality Car Care service.

**18,000 MILE
FORD QUALITY CAR CARE
COUPON ***

1964 FALCON

I authorize performance of the services specified on the stub of this coupon. I understand that I will be charged \$_____ for this work. There will also be a charge for additional lubricants required.

Please also perform the additional services I have listed on the back of this coupon.

Date _____

Owner Signature

*Or 6 months (whichever occurs first) since 12,000 mile Quality Car Care service.

**30,000 MILE
FORD QUALITY CAR CARE
COUPON**

1964 FALCON

Additional services requested

59100 oil chg &
filter

POINTS

PLUGS

61710 oil chg 10/19/70

70122 oil & filter
chg 4/23/73

**36,000 MILE
FORD QUALITY CAR CARE
COUPON**

1964 FALCON

Additional services requested

Plugs, points
Condensers - 11/3/73
73600 miles

FORD QUALITY CAR CARE CERTIFICATION

This certifies that specified Ford Quality Car Care maintenance operations have been performed as indicated on the back of this stub. Additional work was performed as indicated below.

30,000 MILES

36,000 MILES

Date _____ Mileage _____

Date _____ Mileage _____

Dealership Name

Dealership Name

Dealership Address

Dealership Address

Signed

Signed

1964 SERVICE LITERATURE

The Ford publications shown on the reverse side can be purchased by filling out the order form and mailing it with a check or money order to Ford Service Publications, Post Office Box 7750, Detroit 7, Michigan.

IMPORTANT: THIS IS YOUR SHIPPING LABEL. PLEASE PRINT CLEARLY.

From . . .	 SERVICE PUBLICATIONS
POST OFFICE BOX 7750 DETROIT 7, MICHIGAN	
FOR:	NAME _____ STREET ADDRESS _____ CITY, ZONE, STATE _____
POSTMASTER: This parcel may be opened for postal inspection if necessary. Return postage guaranteed.	

Tear out along this line

QUANTITY	FORM NO.	DESCRIPTION	PRICE EACH
	7098-64	1964 Ford Shop Manual	\$ 3.75
	7750-64	1964 Thunderbird Shop Manual	3.50
	7780-64	1964 Falcon Shop Manual	3.50
	7780-62	1962 Fairlane Shop Manual	4.00
	7780-63*	1963 Fairlane Shop Manual Supplement. . .	2.25
	7780-64*	1964 Fairlane Shop Manual Supplement. . .	2.75
	7766-61	1961 Econoline and Falcon Bus Shop Manual	3.50
	7766-63*	1962-63 Econoline and Falcon Bus Shop Manual Supplement	2.00
	7766-64*	1964 Econoline and Falcon Bus Shop Manual Supplement	2.25
	7202-64	1964 Ford Service Specification Booklet. . .	.60
	7514-64	1964 Quick Reference Parts and Accessories Catalog	1.00

*Previous year model manual must be ordered with this supplement to obtain complete coverage.

All orders will be mailed within 10 days of order. Please allow ample time for postal service.

A complete list of Ford Motor Company service publications can be obtained upon request from the Ford Service Publication Department, P.O. Box 7750, Detroit 7, Michigan.

**PRICES ARE SUBJECT TO CHANGE
WITHOUT NOTICE AND WITHOUT
INCURRING OBLIGATION**

NOTE: Purchasers outside Domestic U.S.A. must add 30¢ to each Publication for mailing expense. Funds MUST be payable in U.S. Currency.

Michigan Purchasers Add 4% Sales Tax

Signature of Purchaser _____

Street Address _____

City and State _____

FOR HIGHWAY COMFORT AND SAFETY

After you have carefully planned your trip, how can that long jaunt be made easier? Here are a few suggestions that you may not have tried. Frequent shifting of your body position behind the wheel helps, but in addition, try moving the seat itself. As the seat moves fore or aft, the angle of your right knee must change as you operate the accelerator. Change the seat position only while the car is not moving, though, because sudden movement of your body forward might prove dangerous.

Muscular fatigue has a way of sneaking up on us. When we change body position, we counteract this fatigue, but we can further combat it by conscious mental effort. For instance, have you ever noticed stiffness in your finger muscles as you gripped the steering wheel? If so, you may know that all you need do for relaxation is

simply to tell those muscles that they are too tight—and then consciously relax them!

Feet get tired, too. They may tire because of unduly stiff shoes, uncompromising heels, or excessive warmth. In some cases the solution is simple: try soft, light, open footwear—such as sandals.

To relieve eye fatigue, try varying from time to time the area in front of the car on which you focus as you drive along. Remember, of course, the principle that you should focus proportionately farther ahead as you increase speed. If your eyes tire during daylight driving, good quality sun glasses may solve your problem. Night driving will probably be easier if you dim the instrument panel lights. Consistently severe eye strain

under all driving conditions suggests that a visit to your eye doctor may be in order.

Drive at varying legal speeds for easier highway miles, especially when on a turnpike. Not only is this a safety tip, but also it is one to cut down on fatigue. When you vary speed, you decrease monotony, a cause of fatigue. Also, you will probably find that driving at the low end of the legal speed range is less tiring than driving at the legal maximum.

By all means, stop every couple of hours for coffee, a cold drink, or just to get out and s-t-r-e-t-c-h. The time it takes will be more than made up in comfort and added alertness.

And when you get into the car—**FASTEN YOUR SEAT BELTS.** They are added protection against the contingency that you cannot foresee.

TOWING A TRAILER

A large percentage of trailers can be hauled with the conventional car, with no special equipment, except a proper hitch. These range from the simple utility or luggage trailers, to campers, boat trailers, and medium size vacation travel trailers.

Trailers are classified into three groups.

1. The light trailer such as campers, luggage trailers, and normal size boat trailers, fully loaded weight of less than the car weight.
2. Heavy trailers such as heavy boat trailers and travel trailers, fully loaded weight up to that of the towing car.
3. Trailers exceeding the weight of the car.

In the first classification no special equipment is required except a good reliable hitch. However, in the second and third classifications care must be exercised, both relative to the towing vehicle specifications and hitch recommendations. Your Ford dealer will assist you in obtaining the required special equipment necessary to tow trailers in the second and third classifications.

trailer hitch

Equalizing frame hitch should be installed on all cars which are pulling a trailer, either travel trailer or boat trailer, where the tongue load exceeds 200 pounds. This type of hitch equalizes the tongue load over both the trailer wheels and to both rear and front wheels of the towing vehicle and enables the trailerist to level his car and trailer to the correct position for proper handling.

When hitching your trailer to your car use the trailer jack to lift the trailer tongue above the towing ball on your car, and lower over the ball and lock in position. The front of the trailer should be $1\frac{1}{2}$ inches higher than the back end of the trailer when traveling on the highway. This is accomplished by the equalizing type hitch, and your car should remain level.

backing up a trailer

A little practice of course is necessary to back up a car and trailer combination. A simple rule is to

place your hand at the bottom of the steering wheel, and turn the wheel in the direction you want the back end of the trailer to go.

passing

Always remember that you have a long vehicle behind you. When passing on the highway allow ample room to compensate for the extra trailer length, and the slower maneuverability encountered when pulling the trailer. Allow the right-of-way to faster vehicles.

overheating

When driving in hilly terrain or mountains where the inclines are long or steep, avoid overheating your engine or transmission. This can be avoided by downshifting manually to low gear. Should overheating occur, stop, park the car, put the transmission in neutral, and run the engine at a fast idle until the temperature returns to normal.

INDEX

Accessories	43	Lights Switch	27	Seats —Station Wagon ...	35
Air Conditioner	40	Locks	32	Seat Belts	31
Air Controls	38	Locks—Tailgate	34	Shifting Gears	50
Ash Trays	29	Maintenance		Specifications	60
Cigar Lighter	29	Beauty Maintenance ...	12	Starting the Engine	49
Clock	29	Cooling System Care ...	17	Station Wagon Features ..	34
Controls	25	Electrical System Care..	18	Switches	25
Conventional Transmission	50	General Maintenance ...	14	Temperature Gauge	26
Convertible Top Features..	36	Maintenance Coupons ..	65	Tire Pressures	61
Door Handles and Locks...	32	Mechanical Maintenance	14	Tire Stowage	20
Fordomatic Drive	54	Other Maintenance	16	Towing	24
Fuel Filler Locations	14	Owner's Responsibilities	5	Transmissions	52
Fuel Gauge	26	Tire Care and Stowage..	20	Trouble Diagnosis	22
Fuel Recommendations ...	7	Value of Regular		Turn Indicators	28
Fuses	18	Maintenance	5	Warranty	
Gauges	27	Odometer	26	Battery Warranty	4
Generator Indicator	27	Oil Indicator	27	New Car Warranty	2
Heater	38	Parking Brake	30	Tire Guarantee	4
Hood Opening	33	Pushing	24	Warranty Explanation ..	3
Instruments	25	Quality Care	64	Window Controls	33
Ignition Switch	26	Radio	42	Windshield Wiper-Washer..	28
Keys	26	Seats—Conventional	30		

The descriptions and specifications contained in this manual were in effect at the time the book was approved for printing. Ford Motor Company, whose policy is one of continuous improvement, reserves the right to discontinue models at any time, or to change specifications or design, without notice and without incurring obligation.

The Ford Registered Owner Plan, Warranties and Ford Quality Car Care coupons contained in this manual have been developed expressly for use in the United States and certain neighboring countries. Since their application to Ford Motor Company products sold in foreign countries is subject to local practice, this manual is provided in such instances for purposes of owner operating and maintenance reference only.

Total-performance engineering puts extra value in your 1964 Falcon...

Here are two good ways to keep it there:



1. ALWAYS USE GENUINE FORD REPLACEMENT PARTS

The best way to keep your Falcon running like new is to insist on Genuine FoMoCo and Rotunda replacement parts... precision-made parts engineered to the same high quality standards established for Ford original equipment. This is especially important if you are to enjoy the maximum benefits of Ford's more carefree Twice-a-Year Maintenance. For example, the highly efficient depth-type Rotunda oil filter on your new Falcon is *the* oil filter that made the 6,000-mile or 6-month oil change interval possible... and because all genuine Ford parts are made right—to fit right—to last longer, you'll find it pays to keep your Ford-built car *all Ford* with Genuine FoMoCo and Rotunda Parts.



2. BRING YOUR FORD BACK HOME FOR SERVICE

The men at your Ford dealership know your Ford best, so it stands to reason they can service it best. As Ford Quality Car Care service specialists, they have the special tools and equipment, genuine parts and Ford know-how to keep your new car in top operating condition. They value your business and look forward to servicing your present Ford *today*... your future Fords *tomorrow*.

Your 1964 Falcon needs so little care, it's just good sense to give it the best!

A PRODUCT OF



MOTOR COMPANY